

User's Guide

HP 70004A

Color Display



HP Part No. 70004-90061
Printed in USA January 1998

Edition A.0.0

Notice

The information contained in this document is subject to change without notice.

Hewlett-Packard makes no warranty of any kind with regard to this material, including, but not limited to, the implied warranties of merchantability and fitness for a particular purpose. Hewlett-Packard shall not be liable for errors contained herein or for incidental or consequential damages in connection with the furnishing, performance, or use of this material.

Restricted Rights Legend.

Use, duplication, or disclosure by the U.S. Government is subject to restrictions as set forth in subparagraph (c) (1) (ii) of the Rights in Technical Data and Computer Software clause at DFARS 252.227-7013 for DOD agencies, and subparagraphs (c) (1) and (c) (2) of the Commercial Computer Software Restricted Rights clause at FAR 52.227-19 for other agencies.

Trademarks

ITEL is a U.S. trademark of Intelligent Interfaces Inc.

©Copyright Hewlett-Packard Company 1990, 1998

All Rights Reserved. Reproduction, adaptation, or translation without prior written permission is prohibited, except as allowed under the copyright laws.
1400 Fountaingrove Parkway, Santa Rosa, CA 95403-1799, USA

Certification

Hewlett-Packard Company certifies that this product met its published specifications at the time of shipment from the factory. Hewlett-Packard further certifies that its calibration measurements are traceable to the United States National Institute of Standards and Technology, to the extent allowed by the Institute's calibration facility, and to the calibration facilities of other International Standards Organization members.

Warranty

This Hewlett-Packard instrument product is warranted against defects in material and workmanship for a period of one year from date of shipment. During the warranty period, Hewlett-Packard Company will, at its option, either repair or replace products which prove to be defective.

For warranty service or repair, this product must be returned to a service facility designated by Hewlett-Packard. Buyer shall prepay shipping charges to Hewlett-Packard and Hewlett-Packard shall pay shipping charges to return the product to Buyer. However, Buyer shall pay all shipping charges, duties, and taxes for products returned to Hewlett-Packard from another country.

Hewlett-Packard warrants that its software and firmware designated by Hewlett-Packard for use with an instrument will execute its programming instructions when properly installed on that instrument. Hewlett-Packard does not warrant that the operation of the instrument, or software, or firmware will be uninterrupted or error-free.

LIMITATION OF WARRANTY

The foregoing warranty shall not apply to defects resulting from improper or inadequate maintenance by Buyer, Buyer-supplied software or interfacing, unauthorized modification or misuse, operation outside of the environmental specifications for the product, or improper site preparation or maintenance.

NO OTHER WARRANTY IS EXPRESSED OR IMPLIED. HEWLETT-PACKARD SPECIFICALLY DISCLAIMS THE IMPLIED WARRANTIES OF MERCHANTABILITY AND FITNESS FOR A PARTICULAR PURPOSE.

EXCLUSIVE REMEDIES

THE REMEDIES PROVIDED HEREIN ARE BUYER'S SOLE AND EXCLUSIVE REMEDIES. HEWLETT-PACKARD SHALL NOT BE LIABLE FOR ANY DIRECT, INDIRECT, SPECIAL, INCIDENTAL, OR CONSEQUENTIAL DAMAGES, WHETHER BASED ON CONTRACT, TORT, OR ANY OTHER LEGAL THEORY.

Assistance

Product maintenance agreements and other customer assistance agreements are available for Hewlett-Packard products.

For any assistance, contact your nearest Hewlett-Packard Sales and Service Office.

Safety Symbols

The following safety symbols are used throughout this manual. Familiarize yourself with each of the symbols and its meaning before operating this instrument.

CAUTION The *CAUTION* sign denotes a hazard. It calls attention to a procedure which, if not correctly performed or adhered to, could result in damage to or destruction of the product or the user's work. Do not proceed beyond a *CAUTION* sign until the indicated conditions are fully understood and met.

WARNING The *WARNING* sign denotes a hazard. It calls attention to a procedure which, if not correctly performed or adhered to, could result in injury to the user. Do not proceed beyond a *WARNING* sign until the indicated conditions are fully understood and met.

DANGER The *DANGER* sign denotes an imminent hazard to people. It warns the reader of a procedure which, if not correctly performed or adhered to, could result in injury or loss of life. Do not proceed beyond a *DANGER* sign until the indicated conditions are fully understood and met.

General Safety Considerations

- WARNING**
- The instructions in this document are for use by qualified personnel only. To avoid electrical shock, do not perform any servicing unless you are qualified to do so.
 - The opening of covers or removal of parts is likely to expose dangerous voltages. Disconnect the instrument from all voltage sources while it is being opened.
 - The power cord is connected to internal capacitors that may remain live for five seconds after disconnecting the plug from its power supply.
 - This is a Safety Class 1 Product (provided with a protective earthing ground incorporated in the power cord). The mains plug shall only be inserted in a socket outlet provided with a protective earth contact. Any interruption of the protective conductor inside or outside of the instrument is likely to make the instrument dangerous. Intentional interruption is prohibited.
 - For continued protection against fire hazard, replace fuse only with same type and ratings, (type nA/nV). The use of other fuses or materials is prohibited.
-

- WARNING**
- Before this instrument is switched on, make sure it has been properly grounded through the protective conductor of the ac power cable to a socket outlet provided with protective earth contact.

Any interruption of the protective (grounding) conductor, inside or outside the instrument, or disconnection of the protective earth terminal can result in personal injury.
 - Before this instrument is switched on, make sure its primary power circuitry has been adapted to the voltage of the ac power source.





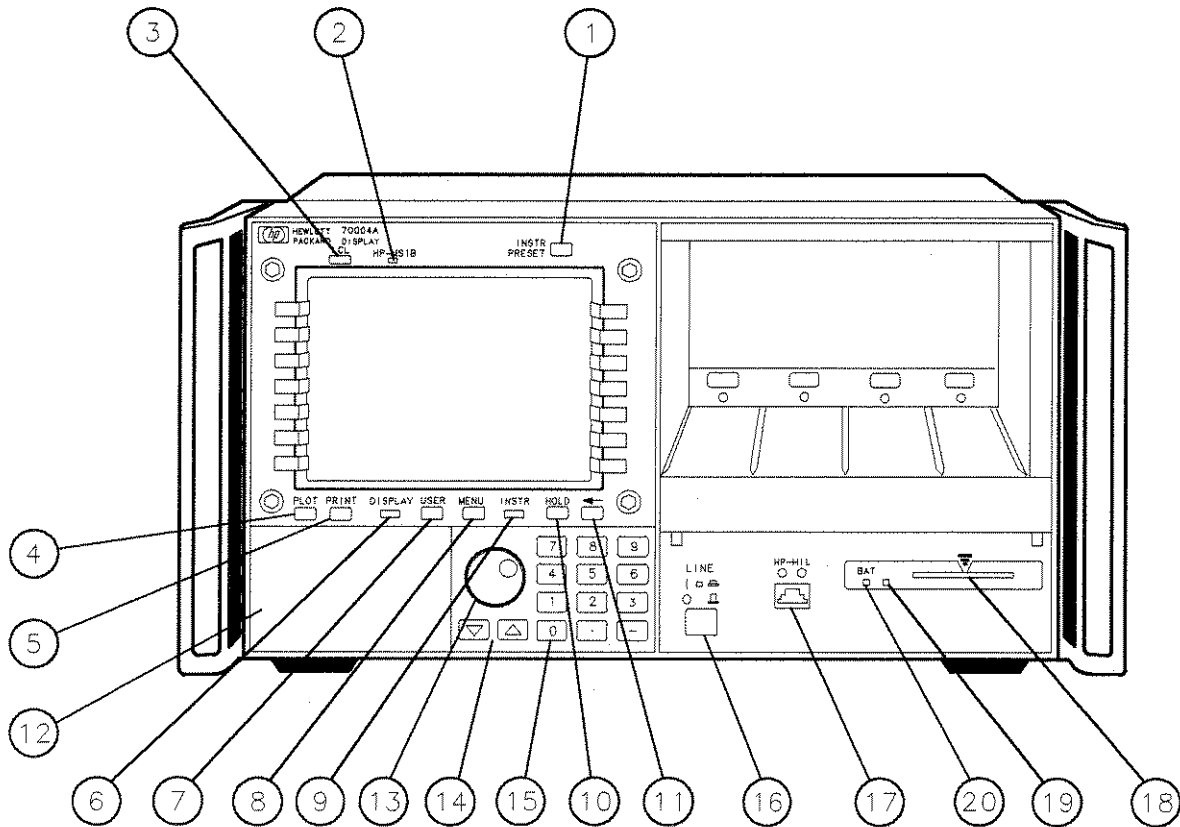





Failure to set the ac power input to the correct voltage could cause damage to the instrument when the ac power cable is plugged in.
-

Operation at a Glance



- | | | |
|---|---------------------|--|
| 1 | INSTR PRESET | Use the instrument preset key to activate all of the preset conditions of the presently selected instrument.

(The DISPLAY PRESET softkey is different from the INSTR PRESET key; when the DISPLAY PRESET softkey is pressed, it clears the screen and breaks all links that it has with any modules and then it offers the screen and a keyboard link to the last module which had the keyboard link.) |
| 2 | MSIB | The MSIB fault indicator light indicates the status of the MSIB. If the light is on, there is an MSIB problem. |
| 3 | LCL | Use the local key to reinstate front panel operation if the instrument has been under remote control. |

- | | | |
|----|---|---|
| 4 |  | Use the plot key to start a vector (HP-GL) plot output of the present display screen over HP-IB. |
| 5 |  | Use the print key to start a raster print output of the present display screen over HP-IB. |
| 6 |  | Use the display key to access all display functions through display softkeys. |
| 7 |  | Use the user key to access user-defined menus or access downloadable programs (DLPs). |
| 8 |  | Use the menu key to access all instrument functions and system control operations. |
| 9 |  | Use the instrument key to move (allocate) the display and keypad between instruments in your system. |
| 10 |  | Use the hold key to deactivate an active function to prevent further control setting changes. |
| 11 |  | Use the backspace key to move from a lower level of menu keys to the previous level or to backspace the cursor while entering text. |
| 12 | Custom Keypad | The custom instrument keypad, provides up to 15 instrument-specific keys on a snap-in panel; the custom instrument keypad is optional and may not be part of your system. |
| 13 | Knob | Use the knob to change parameters and select other operating values; this knob is also referred to as an RPG [Rotary Pulse Generator] knob. |
| 14 |  | Use the two step keys to change parameters up or down. |
| 15 | Numeric Keypad | Use the numeric keypad to enter numeric values. |
| 16 |  | Use the line key to switch the display's line power on and off. |
| 17 | HP-HIL | Use the HP-HIL port to connect HP-HIL devices. Some devices supported by HP-HIL include the HP 46021A and HP 98203C keyboards, HP mouse, and track ball. |
| 18 | Memory Card Slot | The memory card slot provides additional memory for saving and recalling instrument states, data, user keys, traces, and programs. |
| 19 | Memory Card Access Light | The memory card access light indicates that the memory card is being read or data is being written on it. |
| 20 | BAT | The memory card battery-low light indicates a low battery condition on the memory card. The light is off if the memory card is not inserted. |

In This Book

This book describes all of the operation procedures and softkeys available under the **DISPLAY** key.

Chapter 1 “Hardware Installation”, provides information for preparing an HP 70004A color display for use and using it as part of the structural environment for installing and configuring instrument modules into HP 70000 Series modular measurement systems.

Chapter 2 “If You Have Problems”, provides information to help identify and resolve some common problems that may occur during or after installation and provides information for system verification of operation tests.

Chapter 4 “Operating”, provides instrument specific front-panel operation instructions.

Chapter 6 “Programming/Remote Operation”, provides information on remote programming and remote operation over HP-IB.

Chapter 7 “Specifications and Characteristics”, lists the specifications and characteristics of the HP 70004A color display.

Chapter 3 “Front and Rear Panels”, describes the menu keys (softkeys and front-panel keys) as well as various features available through the front-panel and rear-panel of the HP 70004A color display.

Chapter 5 “Softkey Reference”, describes all of the softkeys available through the **DISPLAY** key.

Chapter 8 “Error Messages”, provides error code information about errors that are reported on the HP 70004A color display.

Chapter 9 “Concepts”, provides concept information that is related to the use of the HP 70004A color display.

An index is also added at the end of this user’s guide to aid the user in finding key items of interest.

Notation Conventions

This book uses the following notation conventions:

- KEY** A key name that looks like this represents a key that is physically located on the instrument and is commonly referred to as a front panel key.
- softkey** Text that looks like this (with all lowercase letters) represents a softkey that accesses another menu of related softkeys.
- SOFTKEY** Text that looks like this (with all uppercase letters) represents a softkey that executes its function.
- Display Text** Text that looks like this represents messages that appear on a display.

Before you begin, you should become familiar with the front panel controls. For information on what each control is used for, refer to “Operation at a Glance” and Chapter 3.

Contents

1. Hardware Installation	
Step 1. Unpacking Your HP 70004A Color Display	1-2
Step 2 (Optional). Installing an Instrument Keypad	1-3
Step 3 (Optional). Installing HP-HIL Devices	1-5
Step 4. Connecting Rear Panel Cables	1-7
Step 5. Setting the MSIB and HP-IB Address	1-8
Step 6 (Optional). Connecting for Remote HP-IB Operation	1-9
Step 7 (Optional). Connecting an HP-IB Disk Drive	1-10
Step 8 (Optional). Connecting a printer	1-12
Step 9 (Optional). Inserting a RAM Memory Card	1-14
Step 10. Connecting the AC Line Power	1-15
Step 11 (Optional). Running the Confidence Tests	1-17
Accessories and Options	1-18
2. If You Have Problems	
If the System's Power-On Self Test Fails	2-2
If You Have a Blank or Distorted Display	2-4
If One of the HP 70004A Color Display Fault Indicators is On	2-5
If More Than One Module's Error Indicator is Flashing	2-7
If You Need to Run Display Tests	2-8
If You Have to Clean the Display's Screen	2-14
If You Need to Contact Hewlett-Packard	2-15
Returning Your Color Display to Hewlett-Packard	2-17
3. Introducing the HP 70004A Color Display	
Main Features	3-2
Front Panel Regions and Hard-Labeled Keys	3-4
Instrument Keypads for a Spectrum Analyzer	3-11
HP-HIL Keyboards	3-13
Rear-Panel Connectors and Address Switches	3-16
4. Operating/Local MSIB Operation	
Configuring Display Windows	4-2
Configuring Display Colors	4-16
Configuring the Display Clock	4-20
Printing and Plotting	4-22
Selecting and Saving to External Mass Storage Devices	4-30
Miscellaneous User Tasks	4-38

5.	DISPLAY Softkey Reference	
	DISPLAY Main	5-3
	DISPLAY Hard Copy	5-6
	DISPLAY Mass Storage	5-12
	DISPLAY Adjust Color	5-15
	DISPLAY Config Display	5-21
	DISPLAY Address Map	5-26
	DISPLAY Misc	5-29
6.	Programming/Remote Operation	
	Programming Commands (Quick Reference)	6-1
	Programming Commands (Extention Manual Pages)	6-13
7.	Specifications and Characteristics	
	General Specifications	7-2
8.	Error Messages	
	2000–2999 Usage Errors	8-2
	Display-Disruptive Error Messages	8-3
	6000–6999 Hardware-Warning Errors	8-5
	7000–7999 Hardware-Broken Errors	8-6
	9000–9999 Factory Use Errors	8-7
9.	Concepts	
	Understanding the HP-IB, MSIB, and the Address Map	9-2
	Understanding RGB Video Outputs and Their Use	9-4
	Understanding the Use of Color	9-7

Index

Figures

1-1. Available ac Power Cords	1-19
2-1. Line Voltage Selector	2-2
2-2. Line Fuse Removal and Replacement	2-3
2-3. display tests Menu Keys	2-8
2-4. Confidence Test	2-9
2-5. Key Test	2-10
2-6. Knob Test Display	2-11
2-7. Display ID	2-13
2-8. Typical Serial Number Label	2-15
4-1. RAM Memory Card Battery Replacement	4-35
4-2. Memory Card Date Code Location	4-36
5-1. Main Keys	5-3
5-2. Hard Copy Keys	5-6
5-3. Mass Storage Keys	5-12
5-4. Example of an HP 70900B Local Oscillator Source Accessing an HP-IB Disk Drive	5-13
5-5. Using MSIB to Connect the Display to a Remote Antenna Site	5-13
5-6. Adjust Color Keys	5-15
5-7. Config Display Keys	5-21
5-8. Address Map Keys	5-26
5-9. Misc Keys	5-29

Tables

1-1. Optional Accessories for the HP 70004A Color Display	1-18
1-2. ITEL Interface Models	1-20
2-1. Default MSIB Address Map	2-3
2-2. HP Service Centers	2-16
2-3. Packaging for an 8/8 Module (Color Display)	2-18
5-1. HP PaintJet Color Map	5-7
5-2. Mapping of Display Pens to Plotter Pens	5-9
5-3. Default Values of copy options	5-11
5-4. Default Color Values for the Edit Colors Menu	5-17
5-5. Default Values for the Monochrome Display	5-18
5-6. Red, Green, and Blue Values for Vision Enhnc 1	5-19
5-7. Red, Green, and Blue Values for Vision Enhnc 2	5-19
5-8. Red, Green, and Blue Values for the Optical Filter	5-20

Hardware Installation

This chapter contains information needed to prepare an HP 70004A color display for use in an HP 70000 Series modular measurement system. The information presented is general in nature; for more detailed information on cabling configurations, module placement, and MSIB addressing, refer to the *HP 70000 Modular Spectrum Analyzer Installation and Verification Manual*.

Step 1. Unpacking Your HP 70004A Color Display	1-2
Step 2 (Optional). Installing an Instrument Keypad	1-3
Step 3 (Optional). Installing HP-HIL Devices	1-5
Step 4. Connecting Rear Panel Cables	1-7
Step 5. Setting the MSIB and HP-IB Address	1-8
Step 6 (Optional). Connecting for Remote HP-IB Operation	1-9
Step 7 (Optional). Connecting an HP-IB Disk Drive	1-10
Step 8 (Optional). Connecting a printer	1-12
Step 9 (Optional). Inserting a RAM Memory Card	1-14
Step 10. Connecting the AC Line Power	1-15
Step 11 (Optional). Running the Confidence Tests	1-17
Accessories and Options	1-18

Step 1. Unpacking Your HP 70004A Color Display

1 Unpack your color display from its shipping container.

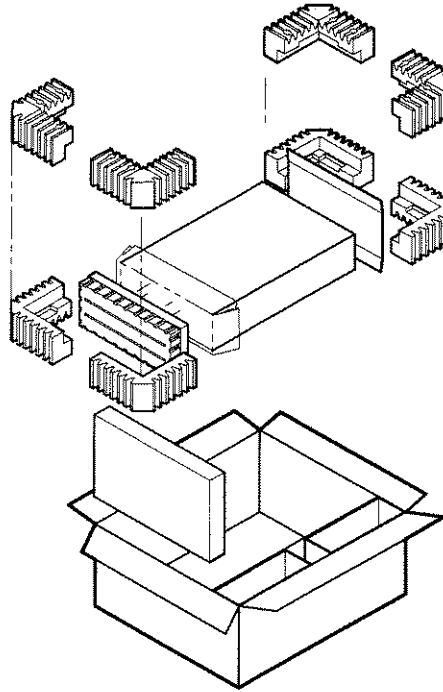

2 Inspect the shipping container and contents thoroughly to ensure that it was not damaged during shipment.

If the container or cushioning material is damaged, check the contents of the shipment both mechanically and electrically. If the contents are damaged or defective, contact your nearest Hewlett-Packard Sales and Service Office. (Refer to Table 2-2.) Keep the shipping materials for the carrier's inspection.

3

Verify that all parts and materials were included in the shipping container. (Refer to Table 1-1 for HP part number listings.)

One:	HP 70004A color display
One:	<i>HP 70004A Color Display User's Guide</i>
One Set:	MSIB Rear Panel Cables
One:	AC Power Cord
(Optional):	HP-IB Rear Panel Cables
(Optional):	Instrument Keypads
(Optional):	HP-HIL devices
(Optional):	Memory Cards

Step 2 (Optional). Installing an Instrument Keypad

To remove an instrument keypad (with release button):

1. Depress the release button, located on the right-hand side of the keypad, and the instrument keypad should snap out.

To install a custom instrument keypad (with release button):

1. Insert the left side of the keypad (2) into the front panel.
2. Press the right side of the keypad until it snaps into the front panel.

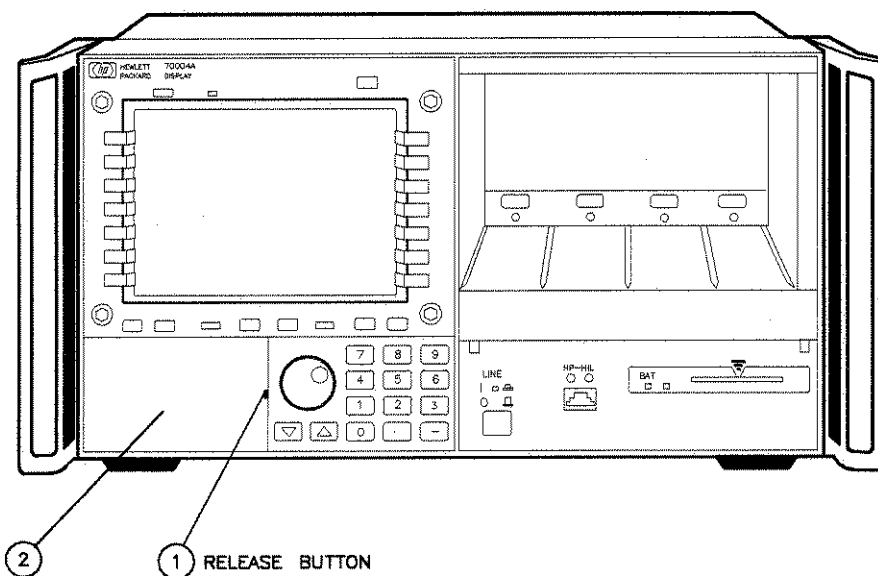

Instrument keypads execute commonly used instrument functions and duplicate operation of corresponding **MENU** softkeys.

There are two different release mechanisms for the blank panel:

If the blank panel has a release button on the right-hand side, use the procedure listed above.

If the blank panel has a slot in the right-hand side, use the procedure on the following page that utilizes a screwdriver.

Step 2 (Optional). Installing an Instrument Keypad

To remove an instrument keypad (without release button):

1. Insert a bladed screwdriver into the keypad's slot (1).
2. Gently pry the screw-driver's handle to the left. The keypad (2) will snap out of the front panel.

To install a custom instrument keypad (without release button):

1. Insert the left side of the keypad (2) into the front panel.
2. Press the right side of the keypad until it snaps into the front panel.

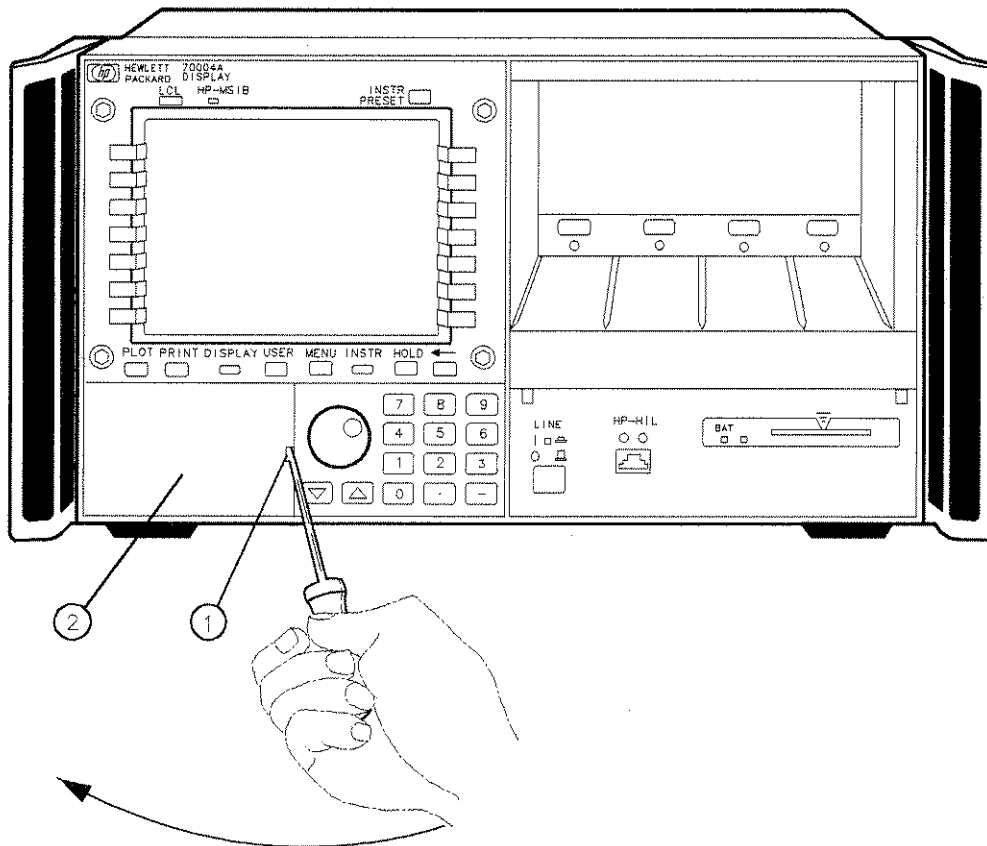

Instrument keypads execute commonly used instrument functions and duplicate operation of corresponding **MENU** softkeys.

There are two different release mechanisms for the blank panel:

If the blank panel has a release button on the right-hand side, use the procedure on the previous page that utilizes a screwdriver.

If the blank panel has a slot in the right-hand side, use the procedure listed above.

Step 3 (Optional). Installing HP-HIL Devices

To connect a HP-HIL keyboard and a mouse:

1. Inspect the two ends of each HP-HIL cable to locate an end with one black dot and an end with two black dots.
2. Plug the two-dot end of the HP-HIL cable into the display's two-dot connector.

The end with two black dots is always plugged into the two-dot connector of the device you are linking from, while the one dot end is always plugged into the one-dot connector of the device you are linking to.
3. Plug the one-dot end of the HP-HIL cable into the one-dot connector on the keyboard.
4. Plug the two-dot end of the HP-HIL cable that came with the HP mouse or track ball into the keyboard's two-dot connector.

Note

The HP mouse has only a two-dot end on its HP-HIL cable. Therefore it must be the last device in the link.

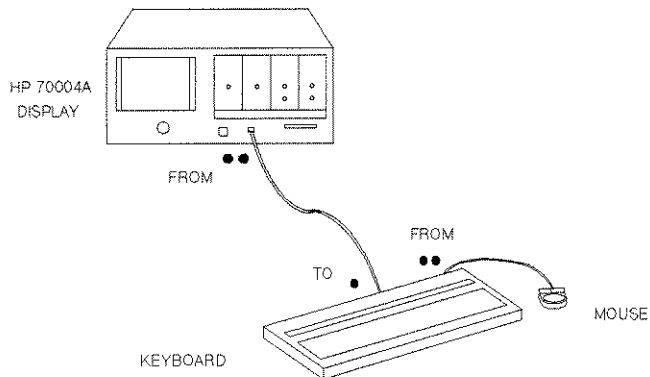

Step 3 (Optional). Installing HP-HIL Devices

To connect an HP mouse or track ball:

- Plug the two-dot end of the HP-HIL cable that came with the HP mouse or track ball into the keyboard's two-dot connector or the two-dot connector of the display; the HP mouse or track ball do not need a keyboard, they can be connected directly to the display.

The HP-HIL interface supports most relative locator devices including the HP mouse and track ball.

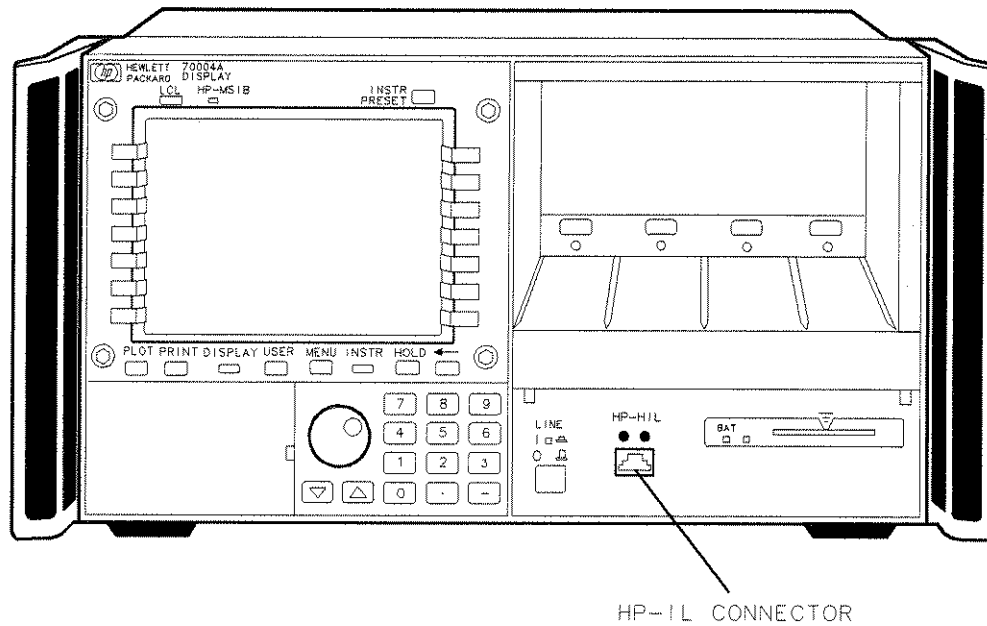

Step 4. Connecting Rear Panel Cables

To connect the display to another display or mainframe:^{1,2}

1. Connect an MSIB cable between the HP 70004A color display's MSIB OUT connector (1) and the HP 70001A mainframe's MSIB IN connector (2).
2. Connect an MSIB cable between the HP 70001A mainframe's MSIB OUT connector (3) and the HP 70004A color display's MSIB IN connector (4).

The MSIB cables are connected serially, coupling the input of one element to the output of the next until the loop is completed.

3. The cabling shown in this diagram is for a generic spectrum analyzer system; for more information about connecting cables between various modules used in an MMS system, refer to the *HP 70000 Modular Spectrum Analyzer Installation and Verification Manual*.

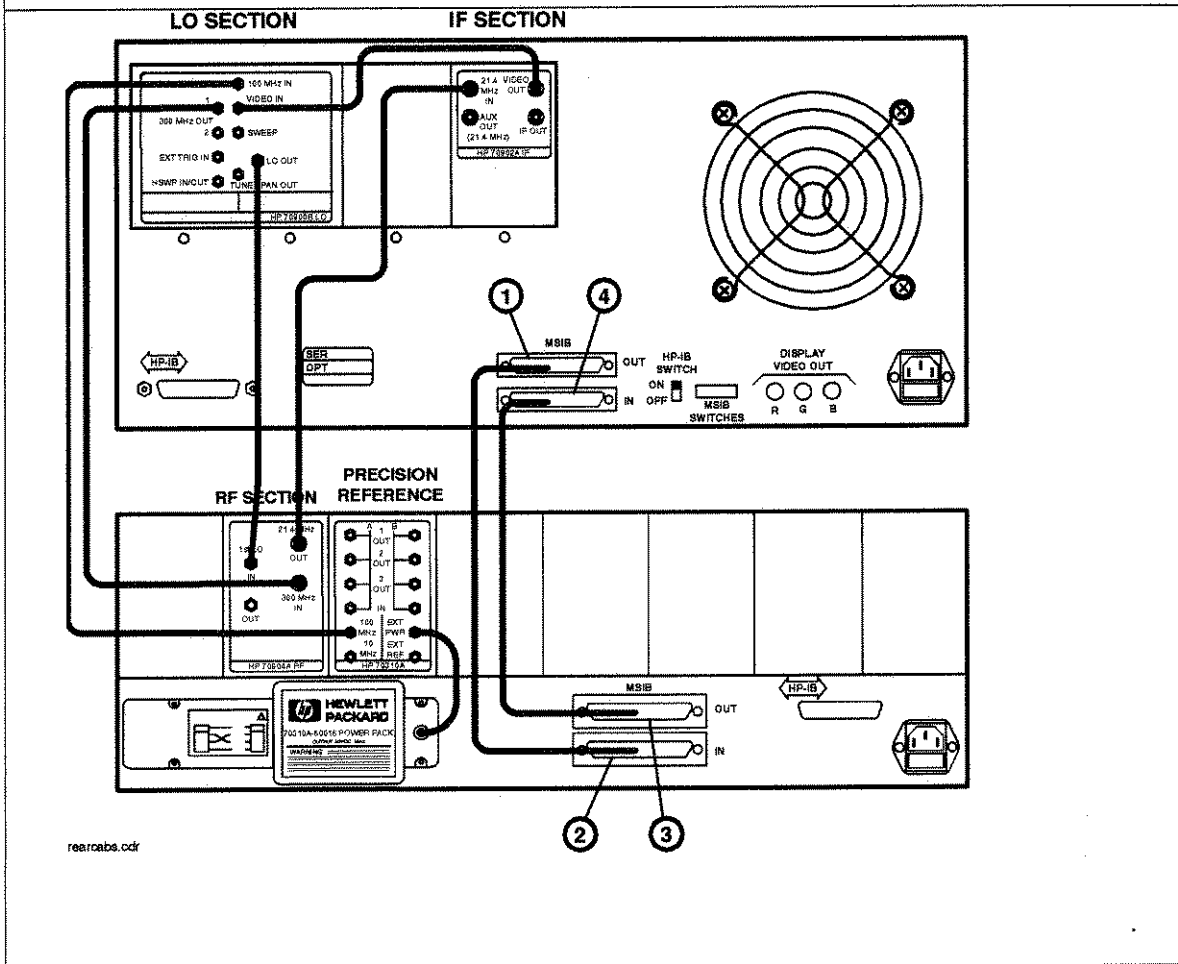

1 Each MMS system is shipped with a unique set of preconfigured cables; the lengths of required cables may vary.

2 For information on connecting to an external monitor, refer to "Understanding RGB Video Outputs and Their Use" in Chapter 9.

Step 5. Setting the MSIB and HP-IB Address

To set the MSIB and HP-IB address switches:

1. Locate the address switches on the rear panel of the display.
2. Set the five switches labeled COLUMN to the binary value of the display's MSIB column address.

Setting the COLUMN address of the display, specifies both the MSIB address and the HP-IB address of the display.

DISPLAY CONFIGURATION

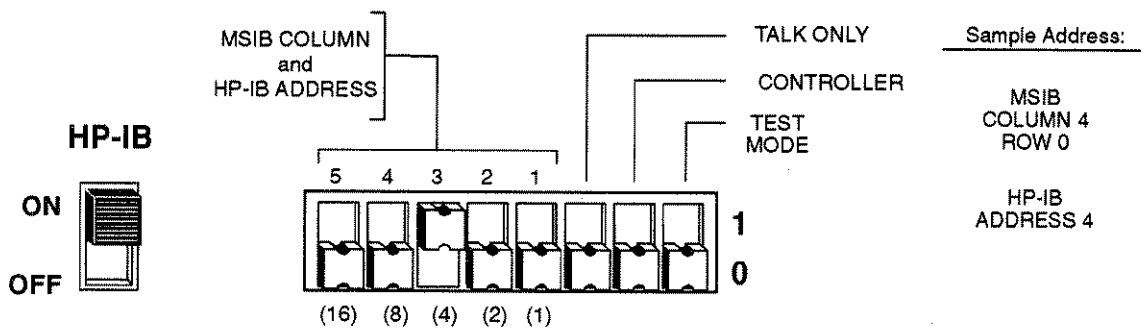

switches.tif

MSIB Address

00000
00001
00010
00011
00100¹

HP-IB Address

0
1
2
3
4

To establish proper system function and MSIB communication, each element in a system must be assigned a unique MSIB address. The MSIB address is selected with an 8-bit binary DIP (dual in-line package) switch; this 8-bit binary DIP switch is preset for each module at the factory and may not have to be changed unless you are using a custom addressing configuration.

Note

Changing MSIB addresses requires an understanding of MSIB addressing rules. If you use a custom addressing configuration, refer to the *HP 70000 Modular Spectrum Analyzer Installation and Verification Manual*.

¹ The display section's MSIB COLUMN address is factory-preset to 4 and may be changed, but the display's MSIB ROW address is permanently set to 0.

Step 6 (Optional). Connecting for Remote HP-IB Operation

To operate the display remotely:

1. Locate the address switches on the rear panel of the HP 70004A color display.
2. Set the HP-IB switch to the ON position.
3. Connect an HP-IB cable between the HP 70004A color display's HP-IB connector (1) and the HP 70001A mainframe's HP-IB connector (2).
4. Connect an HP-IB cable between the HP 70001A mainframe's HP-IB connector (2) and your system controller's HP-IB connector (3).

Your system controller may be any computer/controller (for example, HP 9000 Series 200/300 controller) that supports an HP-IB card.

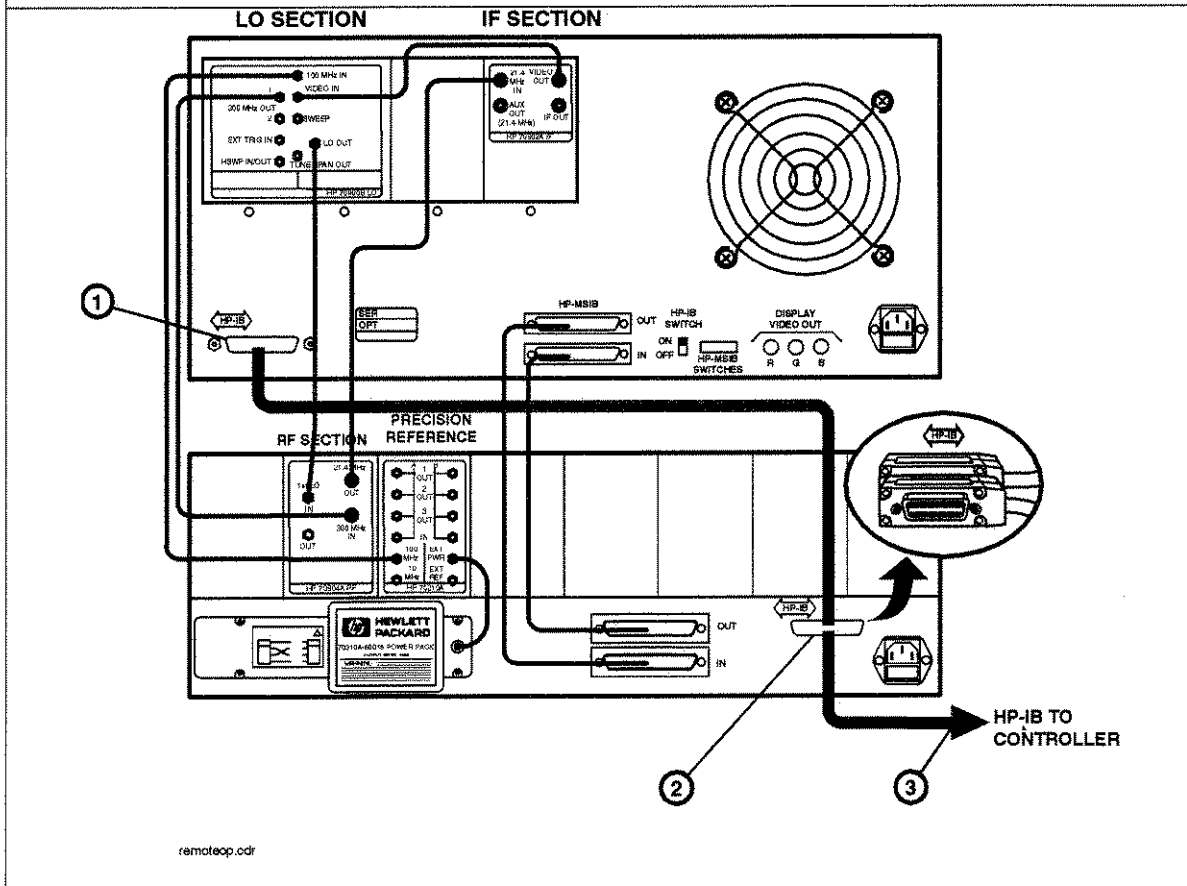

Step 7 (Optional). Connecting an HP-IB Disk Drive

To connect an HP-IB disk drive

1. Locate the HP-IB address switches on the rear panel of the external HP-IB disk drive.
2. Set the HP-IB address switches to 0. Refer to the user's manual for your external HP-IB disk drive if you use a different HP-IB address.
3. Connect an HP-IB cable between the HP 70004A color display's HP-IB connector (1) and the external HP-IB disk drive's HP-IB connector (2).

Refer to Table 1-1 for recommended models of external HP-IB disk drives.

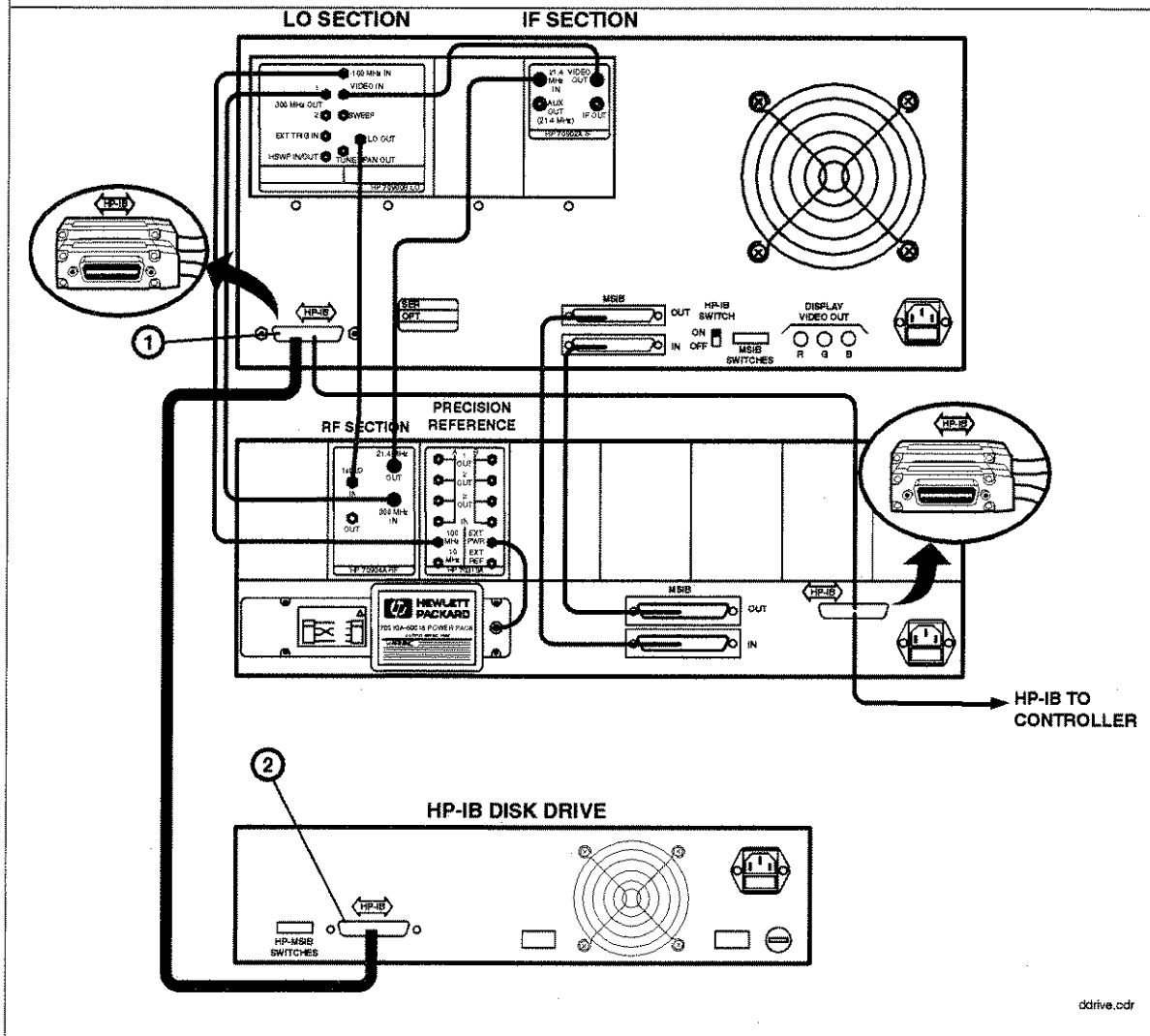

Step 7 (Optional). Connecting an HP-IB Disk Drive

Example of accessing an HP-IB disk drive through an HP 70900B local oscillator source.

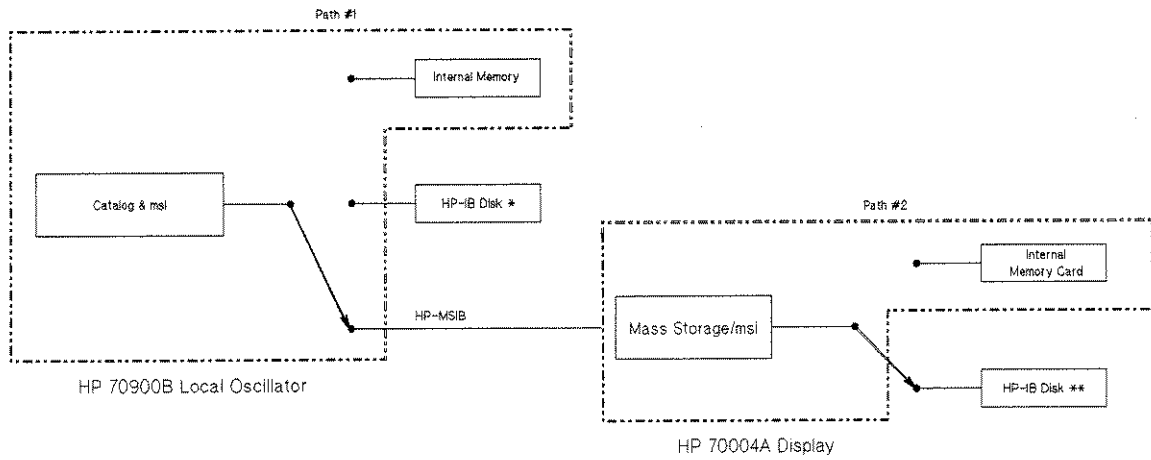

* HP-IB connector on the mainframe that contains the instrument module (can be the mainframe portion of the HP 70004A Display).

** The HP 70004A Display's HP-IB interface

Example of using MSIB to connect to a remote antenna site.

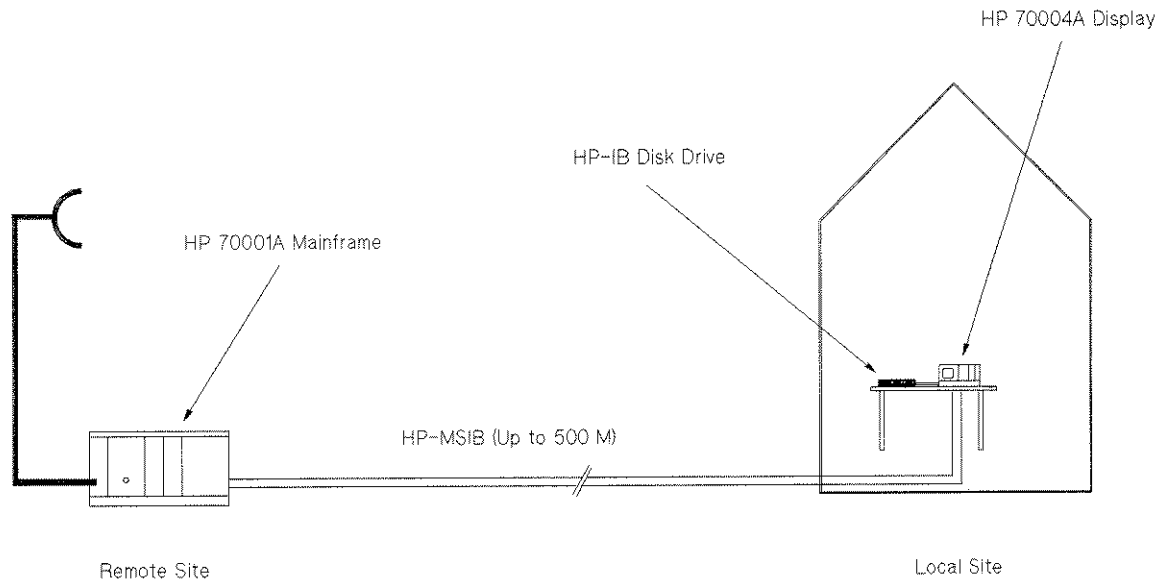

Step 8 (Optional). Connecting a printer

To connect a printer

1. Locate the printer address switches on the rear panel of the printer being connected.
2. Set the address switches to 1. Refer to the user's manual for your printer if you use a different printer address.
3. Connect an HP-IB cable between the HP 70004A color display's HP-IB connector (1) and the "HP-IB" connector (2) on the ITEL interface. (Refer to Table 1-2 for recommended ITEL interface models.)
4. Connect a Centronics printer cable between the "Centronics" connector (3) on the ITEL interface and the printer (4).

To connect a printer to the HP-IB port on the HP 70004A color display, an HP-IB to Centronics converter is required. The Centronics connector is used to connect to the Bi-tronics parallel port on the back of many Hewlett-Packard printers. (Refer to Table 1-2.)

Step 8 (Optional). Connecting a printer

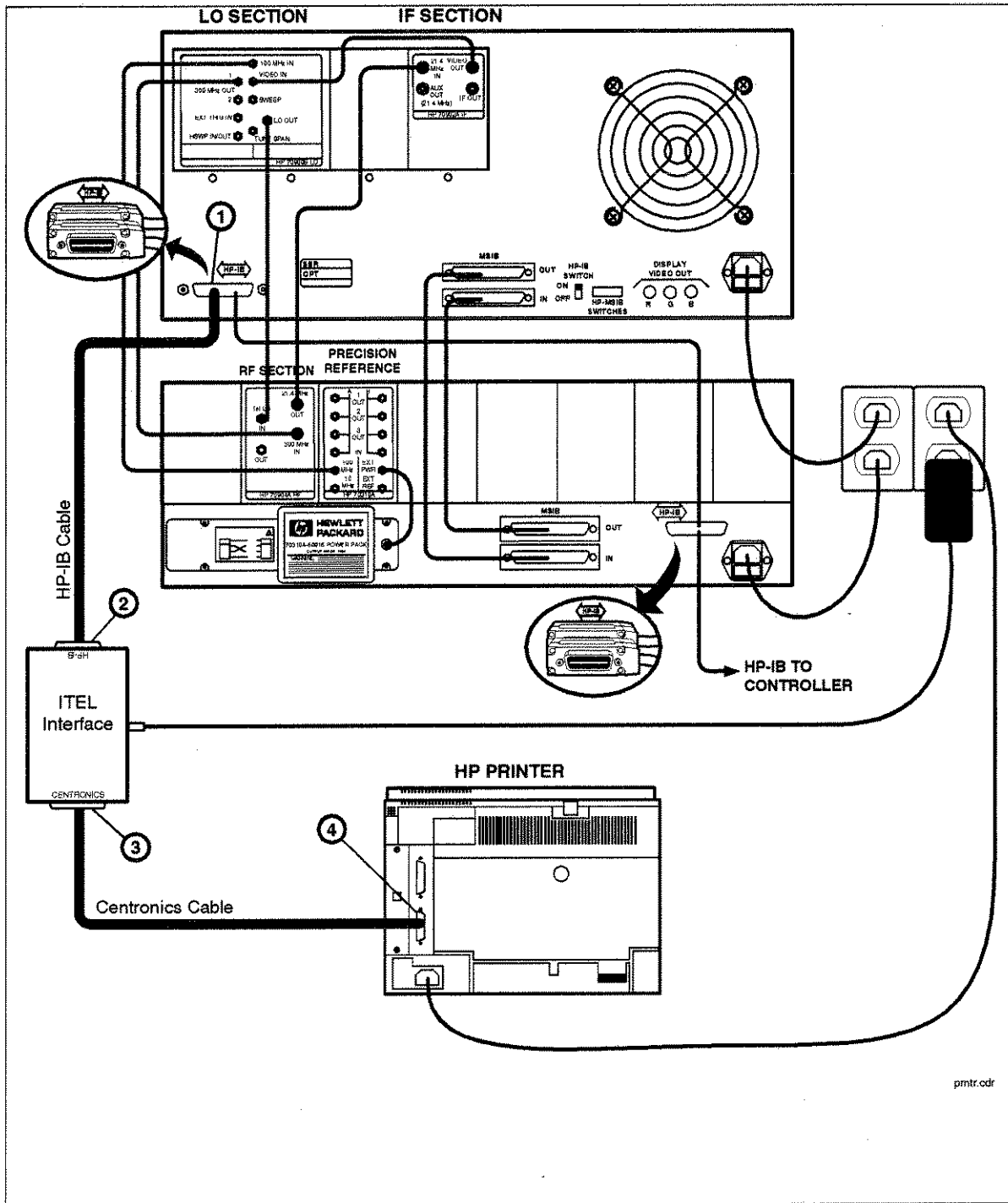

pmtr.odr

Step 9 (Optional). Inserting a RAM Memory Card

To insert a RAM memory card:

1. Locate the arrow printed on the card label.
2. Insert the card with the arrow on the card matching the arrow above the card-reader slot.
3. Press the card into the slot. When correctly inserted, approximately 19 mm (0.75 in) of the card is exposed.

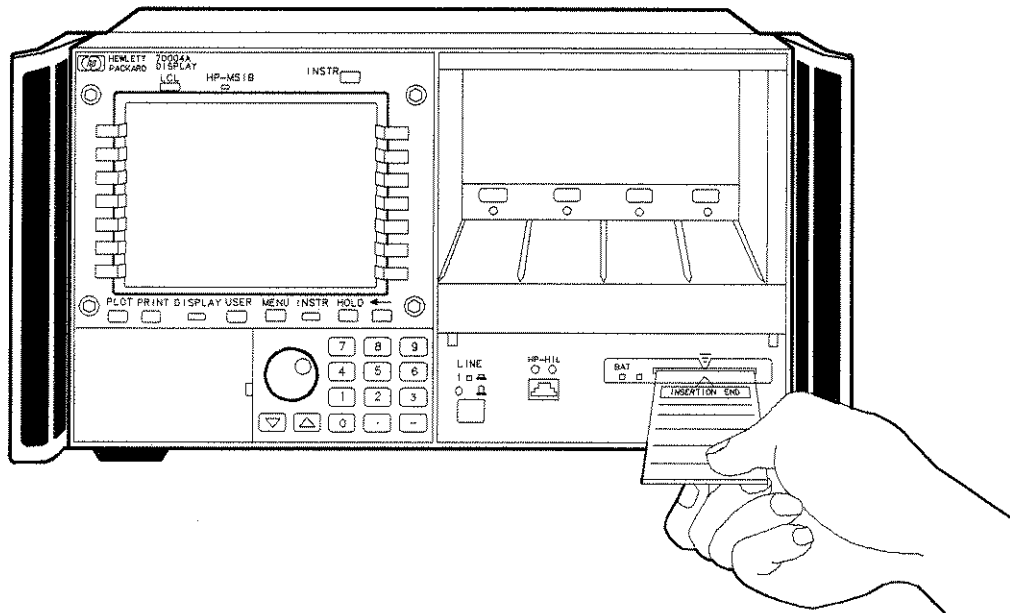

Memory cards provide storage media and access routines and instrument personalities; these are called down-loadable programs (DLPs).

WARNING

Improper card insertion can cause error messages to occur, but generally does not damage the card or instrument. Care must be taken, however, not to force the card into the card reader slot.

Step 10. Connecting the AC Line Power

1 Confirm that the line-voltage selector is set to the proper ac line voltage.

Failure to set the ac power input to the correct voltage could cause one of two things to happen when power is applied:

- If the switch is set to 115 V and the instrument is connected to 230 V, the fuse will blow.
- If the switch is set to 230 V and the instrument is connected to 115 V, the instrument will not turn on.

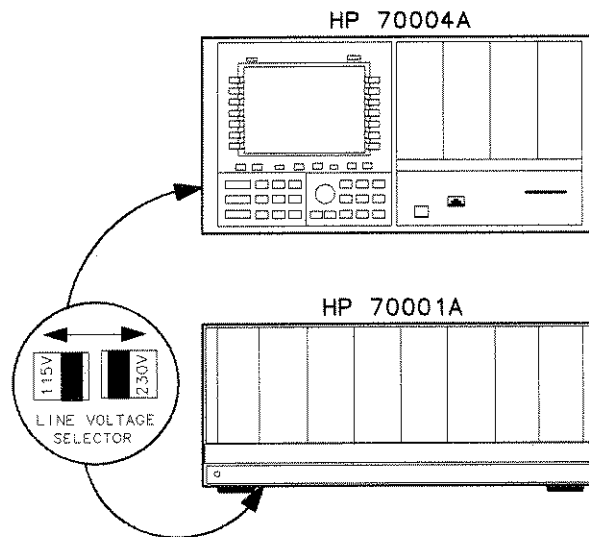

WARNING

Before turning this instrument on, make sure the line-voltage selector is set to the voltage of the ac power source.

- 115 V position for 90 to 132 Vac line input voltages at 50, 60, or 400 Hz
- 230 V position for 198 to 264 Vac line input voltages at 50 or 60 Hz

Also make sure that it is grounded through the protective conductor of the ac power cable to a socket outlet provided with protective earth contact. Any interruption of the protective (grounding) conductor inside or outside the instrument, or disconnection of the protective earth terminal, can result in personal injury.

Step 10. Connecting the AC Line Power

2 Connect the ac power cord to the display or mainframe's rear panel.

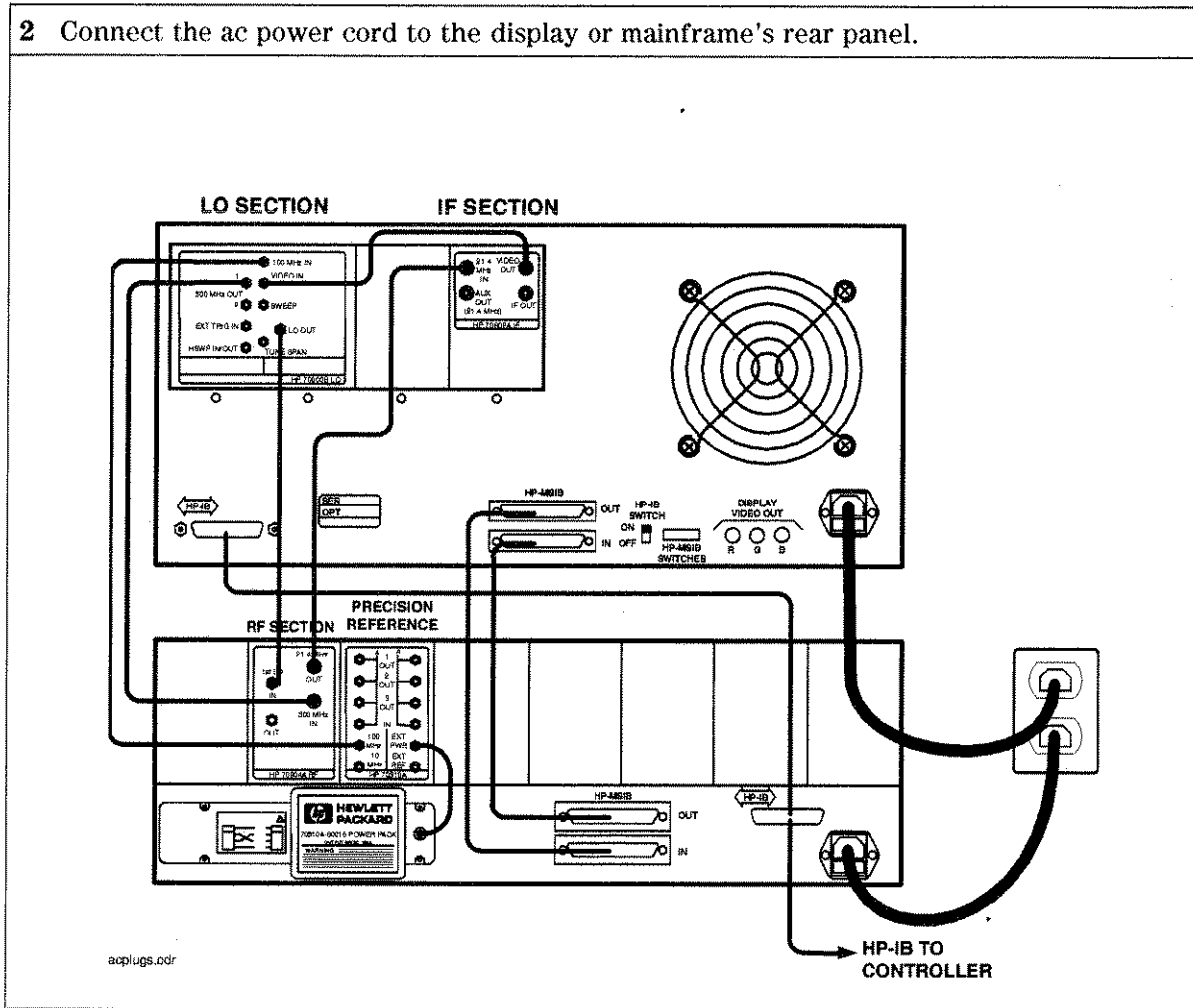

Step 11 (Optional). Running the Confidence Tests

1 Press the **DISPLAY** key.

2 Press the **Misc**, **display tests**, and **CONFID TEST** menu keys to initiate the test.

The Confidence Test checks the operation of roughly 90% of the HP 70004A color display. If the HP 70004A color display fails the Confidence Test, it attempts to write an E (error) in the system state area of the display.

3 Verify that **6001 Confidence test passed** appears in the lower-left corner of the screen.

If the display passes the Confidence Test, and the display screen shows no visible distortion, there is a high level of probability that the display is functioning correctly.

If a fault is found, **6008 Confidence test failed** is displayed. In this event, refer to "If You Need to Run Display Tests" in Chapter 2 for additional information, or contact your nearest Hewlett-Packard Sales and Service Office. (Refer to Table 2-2.)

```

      A      13:40:26 JUL 9, 1989      DISP
Main      CONFID
          TEST

Hard      KEY
Copy      TEST

Mass      KNOB
Storage   TEST
          0 1 2 3 4 5 6 7 8 9 : ; < = > ?
          @ A B C D E F G H I J K L M N O P Q R S T U V W X Y Z [ \ ] ^ _
Adjust    ` a b c d e f g h i j k l m n o p q r s t u v w x y z { | } ~
Color     0 1 2 3 4 5 6 7 8 9 : ; < = > ?
          @ A B C D E F G H I J K L M N O P Q R S T U V W X Y Z [ \ ] ^ _
          ` a b c d e f g h i j k l m n o p q r s t u v w x y z { | } ~
Config    0 1 2 3 4 5 6 7 8 9 : ; < = > ?
Display   @ A B C D E F G H I J K L M N O P Q R S T U V W X Y Z [ \ ] ^ _
          ` a b c d e f g h i j k l m n o p q r s t u v w x y z { | } ~

Address   test
Map       pattern

Misc     service
          modes

6001 Confidence test passed
    
```

At power-on, a set of tests that is different from the Confidence Test is run. The set of tests run at power-on includes tests for the MSIB capability of the display. The display indicates whether any of these tests fail, but does not indicate if they pass. An MSIB failure is indicated by a blinking E (error) indicator in the system state area of the display.

If the Confidence Test produces errors and the MSIB is working (no blinking E indicator), error messages produced by the Confidence Test can be viewed by pressing the **DISPLAY** and **REPORT ERRORS**.

Accessories and Options

The accessories that are supplied with an HP 70004A color display, ordered separately, or as part of a preconfigured HP 70000 Series modular measurement system are the same.

When ordered with a preconfigured HP 70000 Series modular measurement system, cables are supplied to connect the modules in the particular configuration; for information on different configurations or specific cable lengths and HP part numbers, refer to the *HP 70000 Modular Spectrum Analyzer Installation and Verification Manual*.

Table 1-1. Optional Accessories for the HP 70004A Color Display

Group	Description	HP Part Number
Options	Option 913 Rack mount with handles ¹	HP 5062-4073
	Option 908 Rack mount without handles ¹	HP 5062-3979
	Option 010 Rack slide ¹	HP 92576
Instrument Keypads	HP 70820A microwave transition analyzer	HP 70820-60086
	HP 70874A eye diagram analyzer personality DLP	HP 70874-60002
	HP 70900A/B local oscillator source	HP 70900-60208
	HP 70950A optical spectrum analyzer	HP 70950-60033
HP-HIL Devices	Keyboard	HP 46021A
	Keyboard	HP 98203C
	HP-HIL cable ²	HP 46020-60001
	Track ball	HP M1309-60001
HP-IB Disk Drives	3.5" disk drive	HP 9122C
	Hard disk drive	HP 9153C
Memory Cards	32 KB RAM with battery	HP 85700A
	128 KB OTP ³ ROM with battery	HP 85701A
	128 KB RAM with battery	HP 85702A
	256 KB OTP ³ ROM	HP 85703A
	256 KB RAM	HP 85704A
	512 KB RAM	HP 85705A
	512 KB OTP ³ ROM	HP 85706A
AC Power Cables	Power cable	Refer to Figure 1-1. ⁴
Adapters	RCA to BNC Adapter (3 required)	HP 1250-1853
Hex Ball Driver	8 mm hex ball driver	HP 8710-1651
Thin-Film Cleaner	Video Clean Kit	HP 92193
MSIB Cables⁵	HP 70800A 0.5 m MSIB cable	
	HP 70800B 1.0 m MSIB cable	
	HP 70800C 2.0 m MSIB cable	
	HP 70800D 6.0 m MSIB cable	
	HP 70800E 30.0 m MSIB cable	
	HP 70207-60003 2.5 m MSIB Y-cable	
	HP 70207-20003 MSIB cable adapter (2 Quantity)	



¹ For information on how to rack mount your system, refer to the instructions in *HP 70000 Modular Spectrum Analyzer Installation and Verification Manual*.

² This HP-HIL cable is used to connect an HP-HIL keyboard to the HP-HIL connector on the front panel of the HP 70004A color display.

³ This memory card is One Time Programmable (OTP) Read Only Memory (ROM).

⁴ The HP part number of the required ac power plug depends on the country of use.

⁵ To order MSIB cables, in lengths up to 1.2 km, contact Hewlett-Packard. (Refer to "If You Need to Contact Hewlett-Packard" in Chapter 2.)

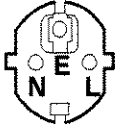
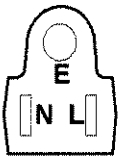
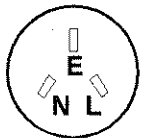
PLUG TYPE **	CABLE HP PART NUMBER	PLUG DESCRIPTION	CABLE LENGTH CM (INCHES)	CABLE COLOR	FOR USE IN COUNTRY	
250V 	8120-1351 8120-1703	Straight* BS1363A 90□	229 (90) 229 (90)	Mint Gray Mint Gray	Great Britain, Cyprus, Nigeria, Singapore, Zimbabwe	
250V 	8120-1369 8120-0696	Straight* NZSS198/ ASC112 90□	201 (79) 221 (87)	Gray Gray	Argentina, Australia, New Zealand, Mainland China	
250V 	8120-1689 8120-1692	Straight* CEE7-Y11 90□	201 (79) 201 (79)	Mint Gray Mint Gray	East and West Europe, Central African Republic, United Arab Republic (unpolarized in many nations)	
125V 	8120-1348 8120-1538	Straight* NEMA5-15P 90□	203 (80) 203 (80)	Black Black	United States, Canada, Japan (100V or 200V), Brazil, Colombia, Mexico, Philippines, Saudia Arabia, Taiwan	
	8120-1378 8120-4753 8120-1521 8120-4754	Straight* NEMA5-15P Straight 90□ 90□	203 (80) 230 (90) 203 (80) 230 (90)	Jade Gray Jade Gray Jade Gray Jade Gray		
250V 	8120-5182 8120-5181	Straight* NEMA5-15P 90□	200 (78) 200 (78)	Jade Gray Jade Gray Jade Gray Jade Gray	Israel	
<p>* Part number for plug is industry identifier for plug only. Number shown for cable is HP Part Number for complete cable, including plug. ** E = Earth Ground: L = Line: N = Neutral.</p>						

plugsig.cdr

Figure 1-1. Available ac Power Cords

Accessories and Options

ITEL Interface Models for Connecting Printers

There are a number of Centronics converter models available for connecting printers to the HP-IB. These models are made by Intelligent Interfaces Inc. (800-842-0888) and are listed in the following table.

Table 1-2. ITEL Interface Models

Version	Model ¹	Transfer Rate
Domestic	ITEL MicroPlot 50 ^{2,3}	35 KB/sec to 50 KB/sec
Domestic	ITEL MicroPrint 45CV ^{2,4}	30 KB/sec
Domestic	ITEL MicroPrint 45CXA ^{2,5}	30 KB/sec
Domestic	ITEL MicroPrint 45CHVU ^{2,6}	15 KB/sec
International	ITEL MicroPrint 45CHVE ⁷ Adapters F1011A #ABB (EUROPE) F1011A #ABU (UK) F1011A #ABG (AUS) F1011A #ACQ (S. AFRICA)	15 KB/sec

1 To order various models, contact HP DIRECT 1-800-538-8787.

2 ITEL MicroPlot 50 is a product of Intelligent Interfaces Inc. This model comes with the appropriate ac transformer for use in North America, Japan, Korea, and Taiwan.

3 This model emulates Hewlett-Packard plotters.

4 ITEL MicroPrint 45CV is a product of Intelligent Interfaces Inc. This model puts LaserJets in HPGL mode without the need to set DIP switches like those used with the Model ITEL MicroPrint 45CXA.

5 ITEL MicroPrint 45CXA is a product of Intelligent Interfaces Inc. This unit can be ordered with a variable resolution option which allows the resolution of the printer to be set via DIP switches (it sends the appropriate escape sequences). This option is useful when the printer defaults to high-resolution mode which can cause a printout to be about the size of a postage stamp. This is a common occurrence when other HP-IB instruments dump traces to DeskJet Portable printers.

6 ITEL MicroPrint 45CHVU is a product of Intelligent Interfaces Inc.

7 ITEL MicroPrint 45CHVE is a product of Intelligent Interfaces Inc. This model is for international use and does not come with a particular ac transformer; an ac transformer must be ordered separately.

If You Have Problems

This section contains information to help identify and resolve some common problems that may occur with your color display before the need for extensive servicing.

Symptoms of various problems are listed at the top of each page. Most symptoms have a brief description or explanation to help provide more insight into their cause. A possible cause for the symptom and a checklist of possible solutions are then presented. Use this checklist as an aid to correct the problem.

If the System's Power-On Self Test Fails	2-2
If You Have a Blank or Distorted Display	2-4
If One of the HP 70004A Color Display Fault Indicators is On	2-5
If More Than One Module's Error Indicator is Flashing	2-7
If You Need to Run Display Tests	2-8
If You Need to Contact Hewlett-Packard	2-14
Returning Your Color Display to Hewlett-Packard	2-16

If the System's Power-On Self Test Fails

Each time the HP 70000 Series modular spectrum analyzer system is turned on, the system runs through an initializing routine (power-on self test) during which the front panel STATUS LEDs on each module flash on momentarily and then turn off.

The display also executes a power-on self-test when power is applied. If the test fails, the display terminates the sequence and displays an error on the screen in large block letters. One of the instrument functions tested is the ability of the display section to communicate on the system bus (MSIB). The results of the test can be determined by examining the system state area located in the upper-left corner of the display screen.

The following conditions for the display section should exist after the power-on self-test:

- The MSIB fault indicator should be off.
- The display's fan noise will be scarcely noticeable.

If the system passes the power-on self test, the MEASURE LED on the local oscillator module begins blinking on and off (triggered by the system sweep), and the ACT LED on each active module's front panel is turned on.

Common problems that may occur:

- If any module fails the power-on self test, it will not establish a link with the display.
- If the front panel LEDs on the HP 70900A/B local oscillator source flash on and off, it means the instrument has failed the power-on self test.
- If the display section's power-on self test fails, a blinking E will appear in the status box of the display.

This error is the same as the red LED marked "ERR" on other HP 70000 Series modules. Its purpose is to indicate an error detected in the system on MSIB row 0 of the address map.

To solve these common problems:

- Check that the HP 70900A/B local oscillator source is powered on.
- Check that the HP 70000 Series modular spectrum analyzer system display and mainframe are plugged into the proper ac line voltage.
- Check that the line socket has ac line voltage.
- Check that the line voltage selector switch is set to the correct voltage for the ac line voltage being used. The line voltage selector switch is located on the left side of the HP 70004A color display, on the bottom of the HP 70001A mainframe.

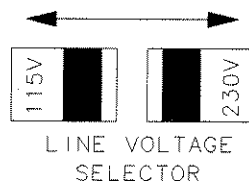

lineselect

Figure 2-1. Line Voltage Selector

- Check the line fuse on the display or the mainframe to ensure that it is not damaged. The line fuse is located inside the power-cord receptacle housing on the rear of the display and

2.2 If You Have Problems

If the System's Power-On Self Test Fails

mainframe. Also included in this housing is a spare fuse. The fuse is a 5 by 20 mm fuse rated at 6.3 A, 250 V (HP part number 2110-0703). This line fuse can be used with both 120 V and 230 V line voltage.

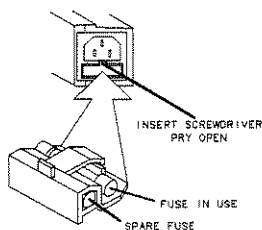

Figure 2-2. Line Fuse Removal and Replacement

- Check the system interconnections.
- Check the address map as shown in Table 2-1.
- Run the Confidence Test. (Refer to “If You Need to Run Display Tests”.)

The Confidence Test checks the operation of about 90% of the display.

If the Confidence Test runs successfully, the first error was probably a system failure, not a display failure.

- If necessary, obtain service from Hewlett-Packard. Refer to “If You Need to Contact Hewlett-Packard”.

Table 2-1. Default MSIB Address Map

	Column 18	Column 19	Column 20
Row 7	blank	HP 70310	blank
Row 6	RF sections ¹	HP 70300	HP 70620 or HP 70621 ²
Row 5	HP 70907	HP 70301	blank
Row 4	HP 70903	blank	HP 70810 Option 850
Row 3	HP 70911	HP 70620 or HP 70621 ³	HP 70810
Row 2	HP 70700	HP 70600 or HP 70601	blank
Row 1	HP 70902	blank	blank
Row 0	HP 70900	blank	blank

1 This includes: HP 70904A RF section, HP 70905A/B RF section, HP 70906A/B RF section, HP 70908A RF section, HP 70909A or HP 70910A RF section.

2 When preamplifying the lightwave section's input signal.

3 When preamplifying the preselector's or RF section's input signal.

For more information about addressing criteria, refer to *HP 70000 Modular Spectrum Analyzer Installation and Verification Manual*.

If You Have a Blank or Distorted Display

To solve this problem:

- Verify that your display is powered on.
- Verify that the intensity is turned on.
- If necessary, obtain service from Hewlett-Packard. (Refer to "If You Need to Contact Hewlett-Packard".)

If One of the HP 70004A Color Display Fault Indicators is On

Problems external to the display can cause the indicators to turn on.

The HP 70004A color display has four fault indicators:

- An MSIB indicator on the upper-left corner of the front panel.
- A blinking red E in the status box in the upper-left corner of the display.
- A steady red E in the status box in the upper-left corner of the display.
- A red battery-low indicator next to the RAM memory card access slot.

If you have an MSIB fault indicator on

The HP 70004A color display has an MSIB system fault indicator in the upper-left corner of the front panel. This indicator applies to the I/O backplane and all modules in the system, not just the display system; the MSIB indicator should be OFF indicating normal operation. This circuitry senses the readiness of the external MSIB. If the MSIB indicator light is on, MSIB communications are inhibited and the condition must be cleared before the display will operate.

The MSIB indicator light will be on if one of the following conditions is true:

- The external MSIB loop is not complete.

Check that both ends of all MSIB cables are securely connected.

If more than one mainframe is used, or if other elements are connected to the MSIB, all cables must be connected; otherwise, the MSIB will not operate. If a single mainframe with no external elements is used, there should be no MSIB cables connected to the external MSIB connectors of that mainframe, although a single cable looped from the input connector to the output connector will allow the mainframe to operate.

- Not all the elements on the external MSIB loop have the power turned on.

Verify that the power is on to the display, all mainframes, and stand-alone instruments on the external MSIB.

To isolate the problem:

- Disconnect both MSIB cables from the display rear panel. Is the MSIB indicator light still on?

NO The problem is either with the cables or an element that was connected to the display with the cables.

Loop each cable (one at a time) from the display MSIB IN to OUT connectors. If the MSIB indicator comes on, that cable has probably failed. If the light does not come on for any of the cables, then an element connected with these cables is faulty. If an element is determined to be at fault, contact your nearest Hewlett-Packard sales and service office for repair.

YES The HP 70004A color display is probably faulty. Contact your nearest Hewlett-Packard sales and service office for repair.

If One of the HP 70004A Color Display Fault Indicators is On

If you have a blinking E indicator

The E indicator in the status box in the upper-left corner of the display is the same as the red LED marked "ERR" on other HP 70000 Series modules. Its purpose is to indicate an error detected in the system on MSIB row 0 of the address map. A blinking E or ERR LED has a special meaning: it signifies that a problem on the MSIB backplane has been detected during system power-up which may prevent normal communication between any modules (and hence, normal error reporting). Such a problem *must* be resolved before any predictable system operation can take place.

Remove all MSIB cables from the display's rear panel, all modules from the mainframe section, and cycle power.

1. If the red E indicator on the display still blinks, then contact your nearest Hewlett-Packard sales and service office.
2. If the E indicator does not blink, then connect a known good MSIB cable between the rear panel MSIB IN and OUT connectors and cycle power. If the E now blinks, contact your nearest Hewlett-Packard sales and service office for repair.
3. If the red E indicator stops blinking, insert the modules one by one until the E starts blinking. When the indicator starts blinking, check the modules for the same MSIB address.
4. If the E indicator doesn't blink, the problem is probably in another display or mainframe, refer to either the *HP 70001A Mainframe Installation and Verification Manual* or the *HP 70205A Graphics Display and HP 70206A System Graphics Displays Installation and Verification Manual* for more information about mainframe troubleshooting.
5. If the cursor (rectangle) cannot be moved about within the address map after a module has been re-addressed, check to see if two modules have the same row and column address. If so, removal of one of the offending modules is required. See the Installation and Verification Manual for your instrument for instructions.

MSIB addresses must be unique. Setting two HP 70000 Series modular measurement system elements to the same address will create an error and make the system bus (MSIB) inoperative.

If you have a steady E indicator

A module (or the display) has detected an error. Press **DISPLAY** and **REPORT ERRORS** to identify the modules reporting errors. (Refer to the **REPORT ERRORS** key for more information.)

If you have a RAM memory card battery-low indicator light on

The display has a RAM memory card battery-low fault indicator near the memory-card slot in the lower-right corner of front panel.

- The battery-low indicator will indicate on if the battery voltage is too low. The battery-low indicator will be off if there is no RAM memory card in the slot or if a one-time-programmable ROM memory card is being used.

If More Than One Module's Error Indicator is Flashing

The HP 70004A color display communicates with the HP 70000 Series modular spectrum analyzer system over the MSIB. When the STATUS ERR indicator LED on a particular module flashes at a 1 Hz rate, the module cannot communicate over the MSIB.

To solve this problem:

- Try turning off the power to the system and then turning it on again.
- If front panel keys are still responding, check the address map to see that all modules are located in their designated coordinates.
- If front panel keys are not responding and the address map cannot be checked, power-down the system, pull out each module and check its address setting by looking at its address switches.

All modules should conform to the required coordinates on the address map. (Refer to Table 2-1.)

- If your system contains more than one mainframe, check that the MSIB cables are connected such that two cable connections are made to each mainframe. If these cable connections look correct, you may try replacing the MSIB cables with new ones.
- If necessary, obtain service from Hewlett-Packard. (Refer to "If You Need to Contact Hewlett-Packard".)

If You Need to Run Display Tests

The Display Tests are the display diagnostic and adjustment routines. The Display Tests screen is accessed by pressing **DISPLAY** **Misc display tests**.

WARNING Keep in mind that display internal adjustments or repairs should only be attempted by qualified technical personnel.

T A	13:29:50 09 07 1989	DISP
Main		CONFID TEST
Hard Copy		KEY TEST
Mass Storage		KNOB TEST
Adjust Color		TUMBLE FIGURES
Config Display		
Address Map		test pattern
<u>Misc</u>		service modes

Figure 2-3. **display tests** Menu Keys

Confidence Test (**CONFID TEST** Menu Key)

Initiate the Display Confidence Test by pressing the **CONFID TEST** menu key. The Confidence Test checks the operation of roughly 90% of the display. If no fault is found, 6001 confidence test passed appears in the lower-left corner of the screen. If a fault is found, 6008 confidence test failed is displayed.

To run the Display Confidence Test:

1. Press **DISPLAY** **Misc display tests** **CONFID TEST**.

If an error is detected, contact your nearest Hewlett-Packard service office.

If the display passes the Confidence Test, and the display screen shows no visible distortion, there is a high level of probability that the display is functioning correctly. If the display fails the Confidence Test, it attempts to write E (error) in the display status block.

If the MSIB is working, any error messages produced by the Confidence Test can be viewed by pressing the **DISPLAY** and **REPORT ERRORS**.

At power-on, a set of tests that is different from the Confidence Test is run. The set of tests run at power-on includes tests for the MSIB capability of the display. The display indicates whether any of these tests fail, but does not indicate if they pass. An MSIB failure is indicated by a blinking E (error) indicator in the status block.

```

A 13:40:26 JUL 9, 1989 DISP
Main CONFID
TEST
Hard KEY
Copy TEST
Mass KNOB
Storage TEST
Adjust
Color TUMBLE
Config FIGURES
Display
Address test
Map pattern
Misc service
modes
6001 Confidence test passed
    
```

Figure 2-4. Confidence Test

If You Need to Run Display Tests

Key Test Menu Key

The **KEY TEST** menu key allows the user to check the mechanical and electrical operation of every front panel key on the display.

To run the key test:

1. Press **DISPLAY** **Misc display tests** **KEY TEST**.
2. Press any key on the display's front panel. The pressed key will be *echoed* on the screen if the key is working properly.
3. Press the backspace key **←** to exit the Key Test.

If an error is detected, contact your nearest Hewlett-Packard service office.

T	13:35:02 09 07 1999	DISP
	KEYBOARD TEST	
Main	To test the keyboard, press each key. After the key is pressed the key function/label will be displayed.	
Hard	Menu key #1 is the upper right menu key, menu key #8	
Copy	is the upper left menu key. The left arrow key exits the routine.	
Mass		
Storage		
Adjust	Key pressed: PRINT	
Color		
Config		
Display		
Address		
Map		
Misc		

Figure 2-5. Key Test

Knob Test Menu Key

The **KNOB TEST** menu key allows the user to test the front panel knob on the display.

To run the knob test:

1. Press **DISPLAY** **Misc display tests** **KNOB TEST**.
2. Turn the front panel knob clockwise slowly. The numbers in the center of the Knob Test display should increase one by one (from 00 to 39).
3. Turn the front panel knob counterclockwise slowly. The numbers in the center of the Knob Test display should decrease.

If the knob is turned swiftly, the numbers in the center of the display should increase and decrease swiftly. The numbers will change too quickly for you to follow the one-by-one count.

4. Press the back-arrow key **←** to exit the Knob Test.

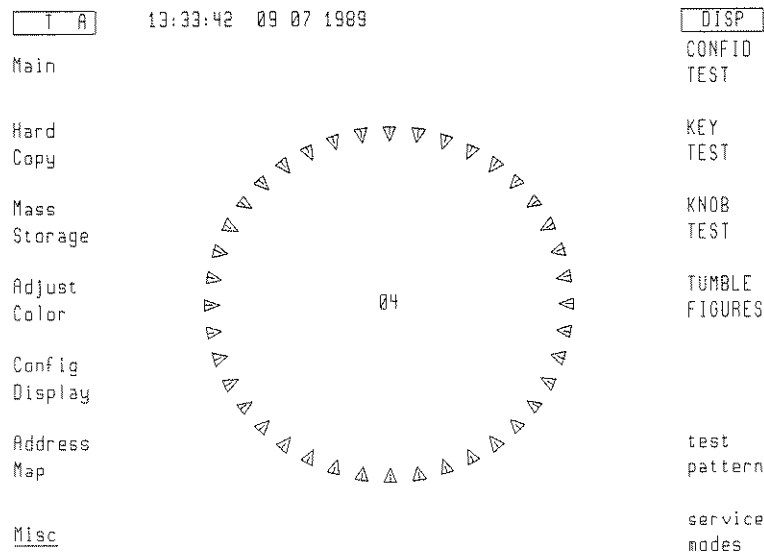



Figure 2-6. Knob Test Display

If You Need to Run Display Tests

Tumble Figures Menu Key

Note While the tumble figures are running, the display cannot communicate on either HP-IB or MSIB. Nor can the display respond to any front panel keys except the back-arrow key  and the **TUMBLE FIGURES** menu keys used to select the various demonstration figures.

The **TUMBLE FIGURES** key allows the user to choose five different demonstration routines:

To run the tumble figures test:

1. Press  **Misc display tests TUMBLE FIGURES**.
2. Press one of the following menu keys: **CUBE**, **BALL**, **SLAB**, **ROD**, or **HALF**.

The tumble figures become larger or smaller when the front panel knob is turned.

3. To exit the tumble figures, press the  key.

Test Pattern Menu Keys

This key provides a menu of test patterns which are used to adjust the display. For explanations of the test patterns and related adjustments, refer to the *HP 70004A Service Guide*.

Display ID Menu Key

When the **DISPLAY** **Misc** **DISPLAY ID** keys are pressed, the screen shows the following information:

- 16 squares with each of the current colors
- HP model number.
- Firmware version.
- MSIB address.
- HP-IB address (OFF if disabled with the rear panel switch).
- Custom Keypad ID Code.

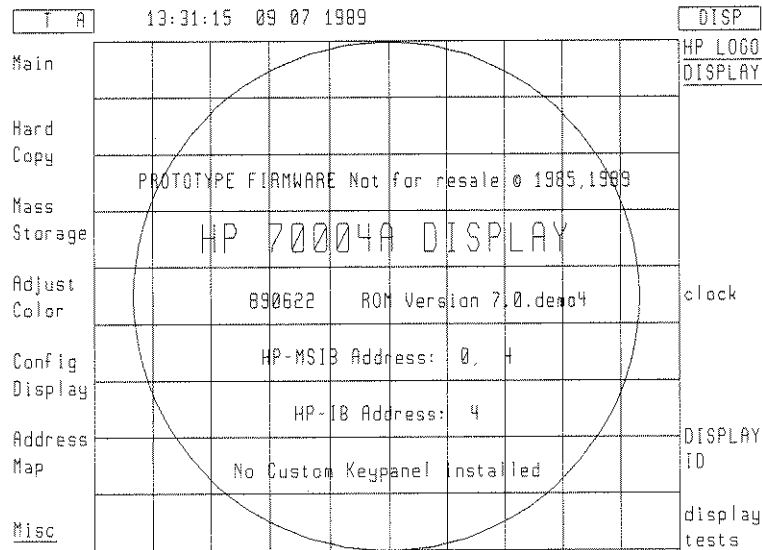

Figure 2-7. Display ID

If You Have to Clean the Display's Screen

To clean the display's screen

To avoid damaging the coating on the display screen, use a thin-film cleaner such as Hewlett-Packard Video Clean Kit (HP part number 92193). The kit includes an abrasion-free cleaning cloth.

If You Need to Contact Hewlett-Packard

Before calling Hewlett-Packard or returning your color display, please read your warranty information. Warranty information is printed at the front of this document.

In any correspondence or telephone conversations, refer to the color display by its full model number and full serial number. With this information, the Hewlett-Packard representative can determine whether your unit is still within its warranty period.

Determining Your Color Display's Serial Number

When a module is manufactured by Hewlett-Packard, it is given a unique serial number. This serial number is attached to a label on the front frame or front panel of the module. A serial number label is in two parts. (Refer to Figure 2-8.)

The first part makes up the serial number prefix and consists of four digits and a letter. The second part makes up the serial number suffix and consists of the last five digits on the serial number label. The serial number prefix is the same for all identical modules; it only changes when a change in the electrical or physical functionality is made. The serial number suffix, however, changes sequentially and is different for each module.

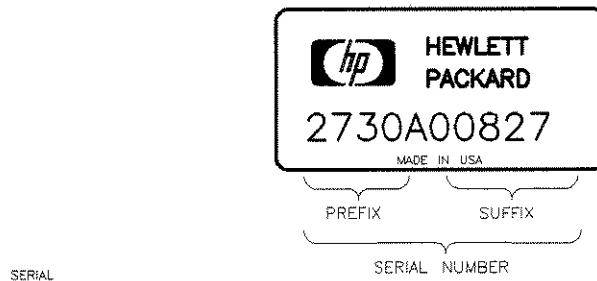

Figure 2-8. Typical Serial Number Label

If You Need to Contact Hewlett-Packard

A current list of Hewlett-Packard Service Centers can be accessed on the Internet at:
<http://www.tmo.hp.com/tmo/contacts/>

If you do not have access to the Internet, one of the following Hewlett-Packard locations can direct you to your nearest Hewlett-Packard representative:

Table 2-2. HP Service Centers

United States	Hewlett-Packard Company Test and Measurement Call Center 24 Inverness Place East Englewood, CO 80112 (800) 403-0801 (800) 857-8161 (FAX)
Canada	Hewlett-Packard Canada Ltd. 5150 Spectrum Way Mississauga, Ontario L4W 5G1 (905) 206-4725 (905) 206-4739 (FAX)
Europe	Hewlett-Packard European Marketing Centre Postbox 667 1180 AR Arnstelveen Netherlands (31/20) 547-6669 (31/20) 647-8706
Japan	Hewlett-Packard Japan Ltd. 27-15, Yabe 1-Chome, Sagamihara, Kanagawa 229 Japan (81426) 567 832 (81426) 567 843 (FAX)
Latin America	Hewlett-Packard Latin America Region Headquarters 5200 Blue Lagoon Drive, 9th Floor Miami, Florida 33126 U.S.A. (305) 267 4245 (305) 267 4288 (FAX)
Australia/New Zealand	Hewlett-Packard Calibration Services Australia Ltd. 31-41 Joseph Street Blackburn, Victoria 3130 Australia 1800 802 540 1800 681 776 (FAX)
Asia-Pacific	Hewlett-Packard Asia-Pacific Ltd. 17-21/F Shell Tower, Times Square 1 Matheson Street, Causeway Bay Hong Kong (852) 25 997 777 (852) 25 069 261 (FAX)

Returning Your Color Display to Hewlett-Packard

Hewlett-Packard has sales and service offices around the world to provide complete support for your color display. To obtain servicing information or to order replacement parts, contact the nearest Hewlett-Packard sales and service office listed in Table 2-2.

Use the following procedure to return your color display to Hewlett-Packard:

1. Fill out a service tag (available at the end of this document) and attach it to the instrument. Please be as specific as possible about the nature of the problem. Send a copy of any or all of the following information:
 - any error messages that appeared on the HP 70000 Series display
 - a completed Performance Test record
 - any other specific data on the performance of the color display

CAUTION Damage can result if the original packaging materials are not used. Packaging materials should be anti-static and should cushion the color display on all sides.

Never use styrene pellets in any shape as packaging materials. They do not adequately cushion the instrument or prevent it from moving in the shipping container. Styrene pellets can also cause equipment damage by generating static electricity or by lodging in fan motors.

2. Place the color display in its original packaging materials.

If the original packaging materials are not available, you can contact a Hewlett-Packard sales and service office to obtain information on packaging materials or you may use an alternative packing material referred to as "bubble-pack". One of the companies that makes bubble-pack is Sealed Air Corporation of Hayward, California, 94545.
3. Surround the color display with at least 3 to 4 inches of its original packing material or bubble-pack to prevent the color display from moving in its shipping container.
4. Place the color display, after wrapping it with packing material, in its original shipping container or a strong shipping container that is made of double-walled corrugated cardboard with 159 kg (350 lb) bursting strength.

The shipping container must be both large enough and strong enough to accommodate your color display and allow at least 3 to 4 inches on all sides for packing material.
5. Seal the shipping container securely with strong nylon adhesive tape.
6. Mark the shipping container "FRAGILE, HANDLE WITH CARE" to help ensure careful handling.
7. Retain copies of all shipping papers.

Returning Your Color Display to Hewlett-Packard

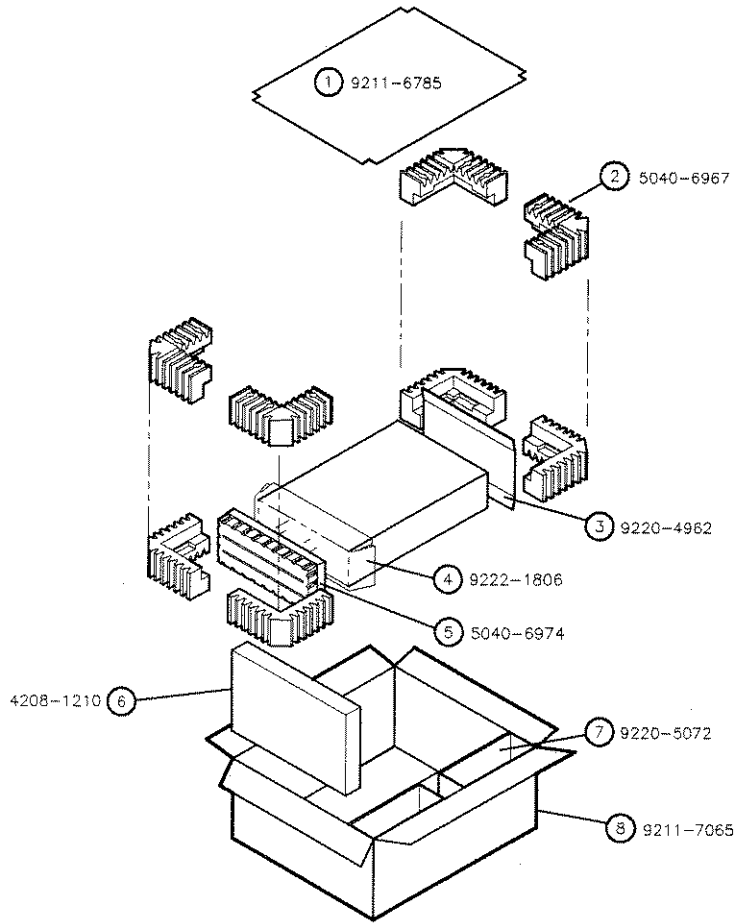

packing8

Table 2-3. Packaging for an 8/8 Module (Color Display)

Item	Description	HP Part Number	Qty
1	Corrugated Carton (Top)	9211-6785	1
2	Foam Corner-Pads	5040-6967	8
3	Flat End-Cap	9220-4962	1
4	Static Sheet	9222-1806	1
5	Front Cover	5040-6974	1
6	Foam Plastic	4208-1210	1
7	Corrugated Pad	9220-5072	1
8	Corrugated Carton (Outer)	9211-7065	1

Introducing the HP 70004A Color Display

Summary In this chapter you will learn about:

- Main features of the HP 70004A color display.
- Regions of the display screen, and the kinds of information that can be found in each region.
- Front panel hard-labeled keys and their use.
- Instrument keypads that can be selected.
- Rear-panel connectors.
- Address switches.

This chapter presents a first look at the HP 70004A color display. You will be introduced to some of the main features. Then, you will learn about the different regions of the display, what each of the front panel hard-labeled keys can do, as well as how to use and access different instrument keypads. Finally, you'll learn about available HP-HIL keyboards, followed by descriptions of the rear-panel connectors and address switches.

Main Features	3-2
Front Panel Regions and Hard-Labeled Keys	3-4
Instrument Keypads for a Spectrum Analyzer	3-11
HP-HIL Keyboards	3-13
Rear-Panel Connectors and Address Switches	3-16

Main Features

The HP 70004A color display is a rugged structure into which modules of various widths can be placed; it serves as the “front panel” for instruments in the HP 70000 Series modular measurement system and provides a graphics display and front panel interface. It is possible to use one display with multiple measurement systems, one display for a single system, or even multiple displays for the same system.

The HP 70004A color display has the following features:

Display Section The display section uses menu keys, data and control keys, and a digital-control knob to assist system operation.

It uses a 7.5-inch diagonal display screen to show system configuration information, measurement results, text, graphics, and built-in trace and marker capabilities in up to 16 simultaneous colors (selectable from a palette of 4096 colors) at a resolution of 1024 horizontal by 400 vertical pixels.

The display section of the HP 70004A color display fulfills the same function as the HP 70206A system graphics display or the HP 70205A graphics display.

Mainframe Section Plug-in modules can be installed in the mainframe section of the display to create different instruments in the modular measurement system. The mainframe section provides the structural environment for plug-in instrument modules along with cooling, power, digital communication interface buses, and EMI shielding that can accommodate 1/8, 2/8, 3/8, and 4/8-width modules, but has a maximum capacity of four 1/8-width modules.

Menu Keys The color display has one screen with 14 menu keys (softkeys). The softkeys are labeled by either the display or the instrument that controls the keyboard. These softkeys are used for all manual instrument control functions; they establish an interactive front panel for any modular instrument.

Module Latch The module hex-nut latch secures modules in the mainframe section. When a module is being installed into or removed from the mainframe section, an 8 mm hex-ball driver is used to turn the module latch screw.

Rack and Stack The display may be stacked or racked with the HP 70001A mainframe or located remotely away from the rest of the system.

Standard rack compatibility is provided, and bench-top use is facilitated with retracting bails and built-in handles. For information on stack or rack kits, refer to *HP 70000 Modular Spectrum Analyzer Installation and Verification Manual*. For more information on obtaining this document, contact your nearest Hewlett-Packard Sales and Service Office. (Refer to Table 2-2.)

MSIB The Hewlett-Packard Modular System Interface Bus (MSIB) supports high-speed digital communication among instrument modules within the display and among instruments connected to the external MSIB loop.

HP-IB Every module that supports HP-IB has access to the standard Hewlett-Packard Interface Bus (HP-IB). This bus provides a path of communication among controllers, other HP-IB instruments, and individual modules.

Power Supplies The HP 70004A color display's power supply processes the ac line power to produce regulated 40 kHz ac power for the modules, 5 Vdc for the MSIB, dc power for the cooling fan, and a TTL-compatible line synchronization signal. The primary power output, 24.3 Vac (average voltage, not rms) at 40 kHz, provides up to 100 Watts of power (25 Watts per 1/8 slot).

The ac power input is switchable between several ranges:

- 87–132 Vac, 47–66 Hz
- 174–264 Vac, 47–66 Hz
- 87–132 Vac, 356–444 Hz

Cooling

A fan provides cooling for both the display and up to four 1/8-width modules.

Remote Programmability

The HP 70004A color display is programmed by modules in a low-level language resembling Hewlett-Packard Graphics Language (HP-GL). It also can be programmed directly through the Hewlett-Packard Interface Bus (HP-IB) in this same language. Information on the display's programming language is available in the *Modular Measurement System Specification*. For more information on obtaining this document, contact your nearest Hewlett-Packard Sales and Service Office. (Refer to Table 2-2.)

Front Panel Regions and Hard-Labeled Keys

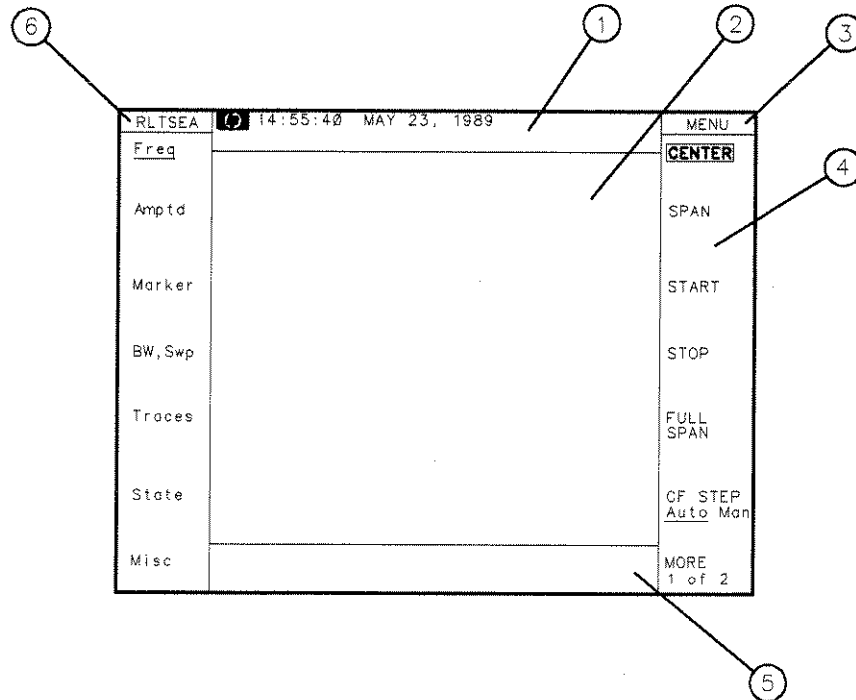

Regions of the Display

Regions of the Display Screen

The display screen is divided into six information regions.

- 1 status information The display uses the status information area to present system status information, such as the real-time clock readout and HP logo.
- 2 graphics The graphics area, which can be subdivided into four windows, displays graphics and text.
- 3 menu status The menu status area displays either MENU, USER, or DISP depending on which menu is being displayed in the softkey menu area. INST is displayed when the user presses the **INSTR** key.
- 4 softkey menus The softkey menu regions display menus accessed through the **DISPLAY**, **MENU**, or **USER** keys.
- 5 character text The character text area (or character line) is one line of text (53 characters long) used for giving prompts and other human interface information.
- 6 system state The system state area contains the letters R L T S E A. Depending on the state of the condition that generates the letters, they may or may not be lit. These letters are defined in the following table.

Front Panel Regions and Hard-Labeled Keys

System State (R L T S E A)

R	HP-IB ¹ Remote, on when the display is in the HP-IB remote mode.
L	HP-IB Listen, on when the display is addressed to listen on HP-IB.
T	HP-IB Talk, on when the display is addressed to talk on HP-IB.
S	HP-IB SRQ, on when the display is asserting SRQ (service request).
E	Error (red), on when there is an error in <i>any</i> module on ROW 0 of the address map. Refer to Chapter 2 and "Understanding the HP-IB, MSIB, and the Address Map" in Chapter 9 for more information about the address map. This error also blinks if the display detects a fault on the MSIB at power-up.
A	Active (green), on when the display controls the keyboard or when the display is being selected in a configuration function.

¹ Hewlett-Packard Interface Bus (HP-IB) fully complies with ANSI/IEEE Standard 488. As such, it incorporates the mechanical, electrical, and functional specifications of the Standard.

Front Panel Regions and Hard-Labeled Keys

Hard-Labeled Keys

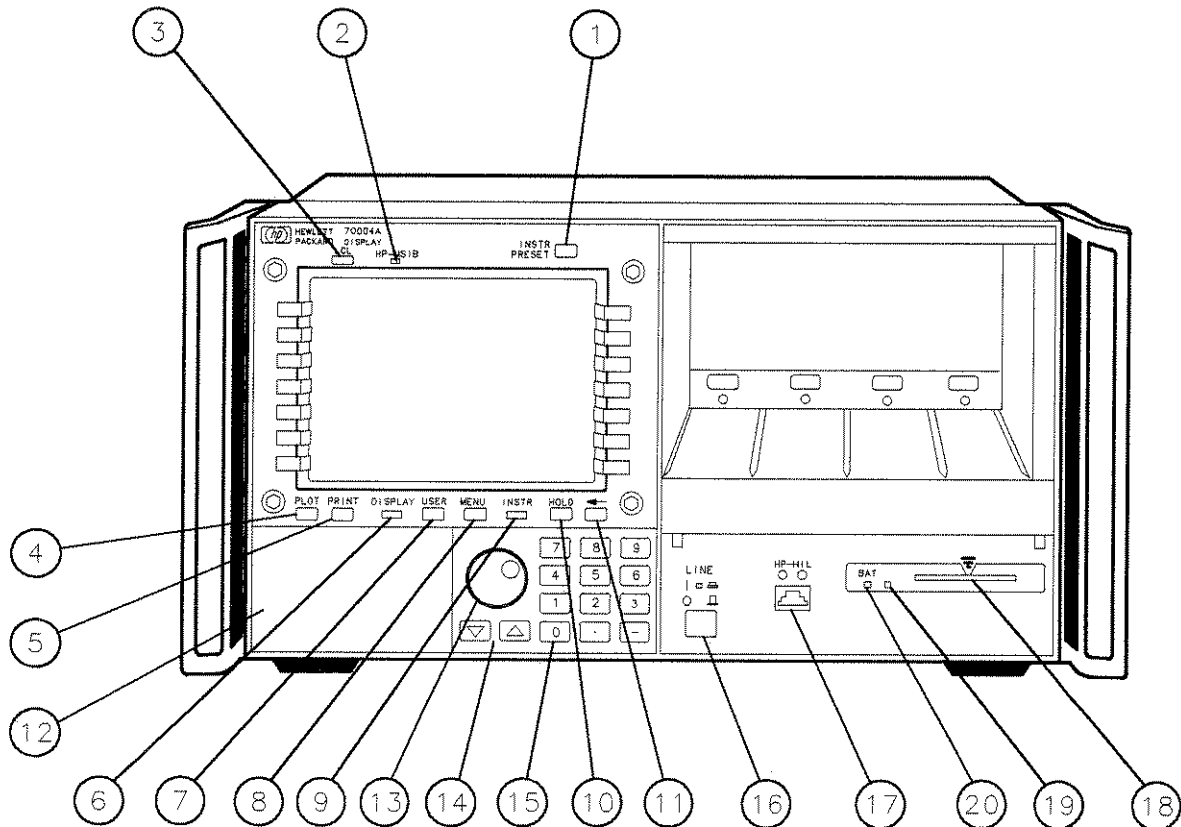

HP 70004A Color Display Front Panel

Use the hard-labeled keys (permanently fixed keys) above and below the display screen to perform such functions as: presetting the instrument, moving the keyboard between instruments in the system, changing parameters with step keys, and printing, as well as many other functions.

The following section lists each available hard-labeled key and describes how each key is used:

INSTR PRESET

(1) The instrument preset key is the green key located on the upper-right corner of the display. It is used to quickly reset the control settings of the instrument to a known preset state.

Use the instrument preset key to activate all the preset conditions of the instrument presently controlled by the keyboard. The **DISPLAY PRESET** softkey is different from the **INSTR PRESET** key; when the **DISPLAY PRESET** softkey is pressed, it clears the screen and breaks all links that it has with any modules and then it offers the screen and a keyboard link to the last module which had the keyboard link. (Refer to "**DISPLAY Main**" in Chapter 5 for more information.)

MSIB

(2) The MSIB fault indicator light indicates the status of the MSIB. If the light is on, there is an MSIB problem or the bus is resetting.

LCL

(3) The local key reinstates front panel operation if the instrument has been under remote control.

PLOT

(4) Use the plot key to start a vector (HP-GL) plot output of the present display screen over HP-IB.

Pressing the plot key initiates a vector plot dump over HP-IB to the plotter specified under **Hard Copy**. The operation of this key is almost identical to the operation of the print key, but the HP-IB output address of the plotter is set using **plotter address** rather than **printer address**.

See the **plotter address** menu key description to set the plotter parameters, including HP-IB address. (Refer to “**DISPLAY Hard Copy**” in Chapter 5 for more information.)

PRINT

(5) Use the print key to start a raster print output of the present display screen over HP-IB.

Pressing the print key initiates a raster print dump of the screen and of the instrument’s menu keys. (Refer to “**DISPLAY Hard Copy**” in Chapter 5 for more information.)

DISPLAY

(6) The display key accesses all of the system and display functions on the HP 70000 Series, whereas the **MENU** key accesses instrument functions. The **DISPLAY** key controls the addressing, communication, and configuration of the instruments in the system.

Softkey Functions This HP 70004A color display manual describes the softkeys accessed by the **DISPLAY** key, but the **USER** and **MENU** keys are described in the *HP 70000 Modular Spectrum Analyzer Operating Manual*.

Pressing the keys around the perimeter of the display screen activates the softkey functions. The softkey functions are organized in levels, with a softkey menu (a set of softkey labels) for each level. The **DISPLAY**, **USER**, and **MENU** keys access the top-level keys.

Menu keys with lower-case labels access lower-level menus; those with upper-case labels access functions directly. Use the previous-menu key, **prev menu**, or backspace **←** key, to return to the previously displayed level of keys.

Some of the softkey functions are too numerous to display all at once, and for this reason are divided into “pages”. Press the **MORE** softkey to view additional pages.

Multi-State Functions Some softkeys switch between two states, such as active on or off, **ACTIVE ON/OFF**, and US or European clock, **US/EURO**. An underscore or

Front Panel Regions and Hard-Labeled Keys

inverse video on the softkey labels indicates which keys and conditions are selected.

USER

(7) The user key is used to access user-defined menus or access down-loadable programs (DLPs). DLPs are one-button measurement routines capable of performing complex measurement sequences without a controller. Refer to your instrument's operation manual for information about transferring functions from the **MENU** key to the **USER** key area.

MENU

(8) The menu key accesses all instrument functions. Use this key to call the top-level softkey menus to the screen.

A multitude of instrument functions are available under the **MENU** key. For example, there are over 150 instrument functions available for the modular spectrum analyzer using the **MENU** key. The exact number depends on the modules present. A different set of menu functions appear for each instrument in your system. For more information, refer to your instrument's operation manual.

INSTR

(9) The instrument key is used to move the display keyboard between instruments in the system.

Depending on how your system is configured, you may have from one to four different instruments displayed simultaneously. (Refer to "**DISPLAY Config Display**" in Chapter 5.)

When the instrument key is pressed, the display puts colored borders around the currently defined windows. Window location, pen number, and the normal colors assigned to those windows are defined in the following table.

INSTR Key Window Assignments

Window	Location	Pen Number	Normal Color
1	Lower Left	2	Yellow
2	Upper Left	3	Cyan
3	Upper Right	4	Pink
4	Lower Right	5	Green

In the softkey location nearest each of these windows is a menu key containing the first seven characters in the instrument's model number on the first line, and the module's MSIB address [row and column (#,#)] on the second. The menu key is displayed in inverse video in the same color as the associated window border. If any of the menu keys are pressed, the keyboard is offered to that window's instrument. If the instrument accepts the keyboard, it will display its menu keys, as if the **MENU** key had been pressed.

Front Panel Regions and Hard-Labeled Keys

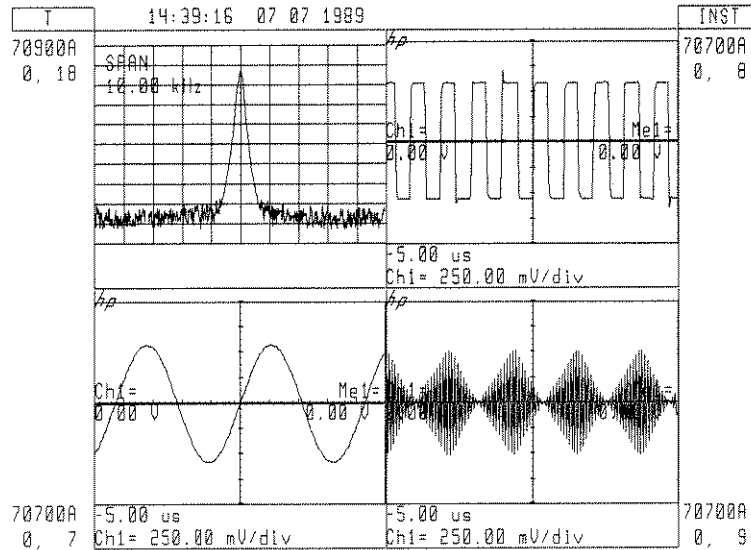

The INSTR Key Display Screen

HOLD

(10) The hold key is used to deactivate an active function and prevent further control setting changes.

For example, on a spectrum analyzer, if **SPAN** menu key has just been set to 1 MHz, it remains the active function. So if the knob is turned or the step keys are pressed accidentally, the span will change to a new value. **HOLD** also removes the active function from the display, and it turns off the inverse video of an active softkey.

If **HOLD** is pressed twice, the menu keys on the right-hand side of the display (while in **MENU**) will be blanked. **INSTR PRESET** also blanks the right-hand menu keys.

←

(11) Use the backspace key to move from a lower level of menu keys to the previous level or to backspace the cursor while entering text.

In the context of the **DISPLAY**, **MENU**, and **USER** functions, the backspace key is used to return to the next higher level of menu functions. A very useful function of the arrow key is to move from the **USER** keys to the last set of **MENU** keys accessed. This eliminates the need to access the **MENU** key and each subsequent level of keys to get to the desired function which you last accessed. The arrow key is also used to exit some of the **display tests** functions.

Custom Keypad

(12) The custom instrument keypad, provides up to 15 instrument-specific keys on a snap-in panel. (Refer to "Instrument Keypads for a Spectrum Analyzer".)

Front Panel Regions and Hard-Labeled Keys

Knob

(13) Use the knob to change parameters and select other operating values; this knob is also referred to as an RPG [Rotary Pulse Generator] knob.



(14) The step keys change parameters up or down.

Numeric Keypad

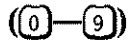

(15) The numeric keypad are used to enter numbers. The number is entered upon pressing the **ENTER** menu key.



(16) The line key switches the display's line power on and off.

HP-HIL

(17) Devices supported by HP-HIL include the HP 46021A and HP 98203C keyboards. (Refer to "HP-HIL Keyboards".)

Memory Card Slot

(18) The memory card slot provides additional memory for saving and recalling instrument states, data, user keys, traces, and programs.

Memory Card Access Light

(19) The memory card access light indicates that the memory card is being read or data is being written on it.

BAT

(20) The RAM memory card battery-low light indicates a low battery condition on the RAM memory card. The battery-low indicator will be off if there is no RAM memory card in the slot or if a one-time-programmable ROM memory card is being used.

Instrument Keypads for a Spectrum Analyzer

A spectrum analyzer instrument keypad is shipped with each HP 70900B local oscillator source. This keypad, designed to plug into the front of an HP 70004A color display, allows the operator to access or activate spectrum analyzer control functions from the front of the HP 70004A color display. The spectrum analyzer instrument keypad can be used with the current LO module and HP 70004A color display firmware.

Each spectrum analyzer control function is enabled by pressing the function key that controls that function. Once enabled, the function (along with its current data value) is displayed both in the active function area of the display and outside the graticule border. To change the value of the active function use the display's data knob, step keys, or numeric keyboard. The following table lists the function keys that are on the spectrum analyzer instrument keypad.

Refer to "Step 2 (Optional). Installing an Instrument Keypad" in Chapter 1 and also refer to the *HP 70000 Modular Spectrum Analyzer Operating Manual* for additional information on its use.

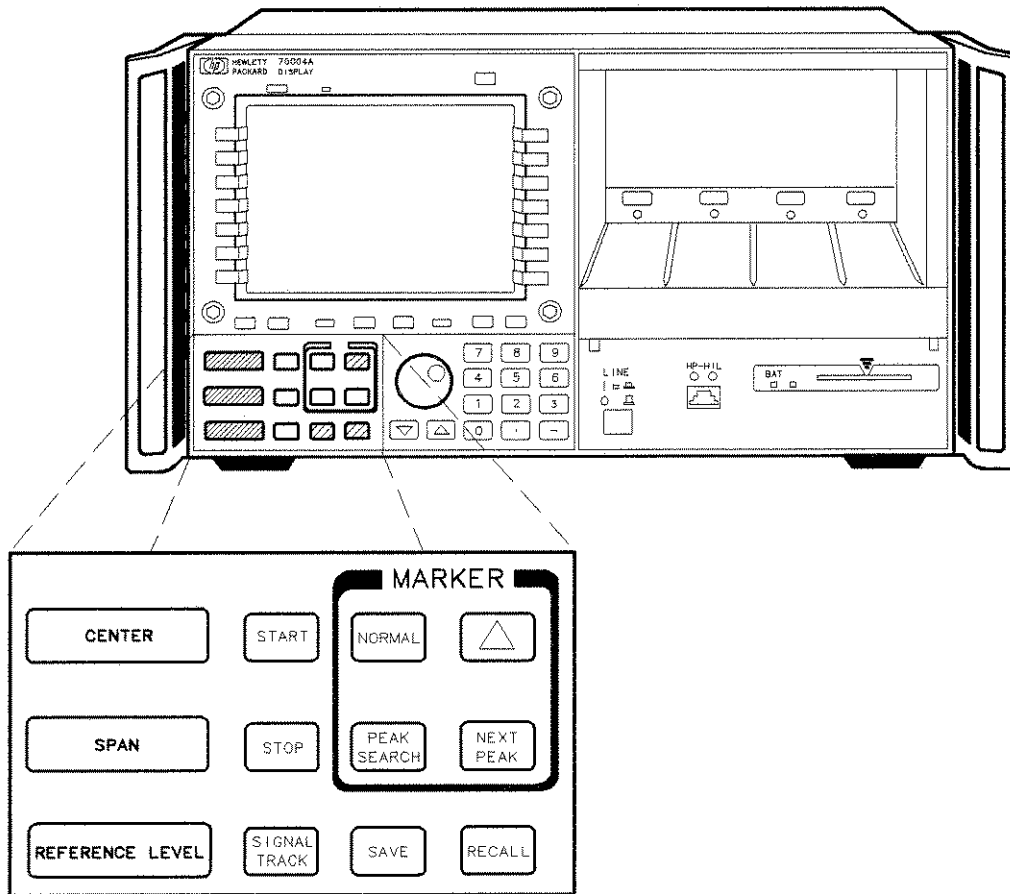

DUA45

Spectrum Analyzer Instrument Keypad

Instrument Keypads for a Spectrum Analyzer

Instrument Keypad Function Keys

Function Key	Description of Function
CENTER	Activates the center frequency function, which can then be tuned continuously over the range of the spectrum analyzer using the data controls.
SPAN	Changes the total display frequency range symmetrically about the center frequency.
REF LEVEL	Changes the absolute amplitude power or voltage represented by the top graticule on the screen.
START FREQ	Sets the frequency at the left side of the graticule.
STOP FREQ	Sets the frequency at the right side of the graticule.
SIGNAL TRACK	Allows the analyzer to automatically maintain drifting signals at the center of the screen. As the signal drifts, the spectrum analyzer is retuned to bring the signal and marker to the center of the screen. This allows real-time monitoring of the change.
NORMAL	Activates a frequency marker at the center of the screen on the active trace. The data controls are used to position the marker. An annotation in the active function area and in the upper-right corner indicate the frequency and amplitude of the marker.
PEAK SEARCH	Places a marker on the higher peak.
Δ	Provides a means of finding and displaying the frequency and amplitude differences (delta) between the two signals with the higher amplitude.
NEXT PEAK	Places the marker on the next higher peak.
SAVE	Saves the spectrum analyzer states to the state registers.
RECALL	Retrieves spectrum analyzer states from the state registers.

HP-HIL Keyboards

The Hewlett-Packard Human Interface Link (HP-HIL) provides an interface to the system by means of an HP 46021A or HP 98203C keyboard.

The keys of an HP-HIL keyboard correspond to the functional softkeys of a Modular Measurement "C" System spectrum analyzer.

The keyboard cable is plugged into the HP-HIL connector located on the front of the HP 70004A color display. (Refer to "Step 3 (Optional). Installing HP-HIL Devices" in Chapter 1.)

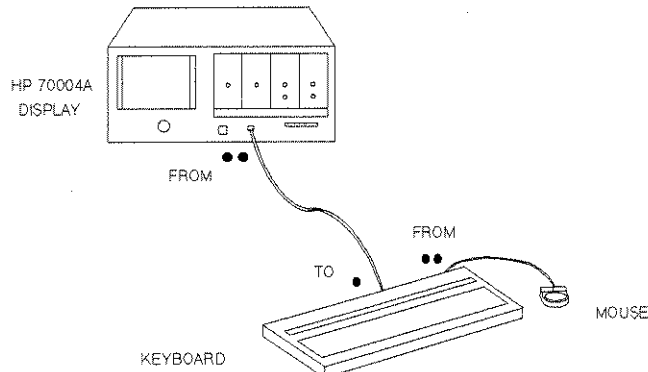

Keyboard Connection

HP-HIL Keyboards

Functional Keycodes

HP 46021A
Keyboard

This keyboard has eight function keys along the top row.

The function keys **(f1)** through **(f7)** on the keyboard correspond to the right-hand softkeys on the display from top to bottom, respectively.

When the **(SHIFT)** key is pressed at the same time a function key is pressed, **(f1)** through **(f7)** on the keyboard correspond to the left-hand softkeys on the display from top to bottom, respectively.

Function key **(f8)** on the keyboard, either shifted or not shifted, corresponds to the **USER** softkey on the display.

The following keys on the HP 46021A keyboard correspond to the indicated spectrum analyzer functions.

Keyboard Function Key	Spectrum Analyzer Function
(Menu)	MENU
(Shift User)	USER
(System)	DISPLAY
(Shift) (Reset)	I-P
(Shift) (Print)	PRINT
(CTRL) (Shift) (Print)	PLOT
(Break)	LOCAL
(Shift) (Clear Line)	CLEAR to END

HP 98203C
Keyboard

This keyboard has 10 function keys in a cluster.

The function keys **(k1)** through **(k7)** on the keyboard correspond to the right-hand softkeys on the display from top to bottom, respectively.

When the **(SHIFT)** key is pressed at the same time a function key is pressed, **(k1)** through **(k7)** on the keyboard correspond to the left-hand softkeys on the display from top to bottom, respectively.

The softkeys **(k8)**, **(k9)**, and **(k10)** on the keyboard, either shifted or not shifted, correspond to the **(USER) (k8)**, **(MENU) (k9)**, and **(DISPLAY) (k10)** keys on the HP 70004A color display.

The following keys on the HP 98203C keyboard correspond to the indicated spectrum analyzer functions.

Keyboard Function Key	Spectrum Analyzer Function
(SHIFT) (PAUSE)	I-P
(SHIFT) (ALPHA)	PRINT
(SHIFT) (GRAPHICS)	PLOT
(SHIFT) (CLR->END)	CLEAR LINE
(CLR I/O)	LOCAL

After a function is selected, the knob on the HP 98203C keyboard can be used to scroll through the available parameters.

Alpha keys

On either keyboard, after the **TITLE** or **COMMAND** mode softkeys have been selected, **(A-Z)**, **(a-z)**, punctuation, **(ins)** and **(DEL)** are used to insert or delete characters into a title or command.

When these keys are pressed, the response is the same as with the **TITLE** or **COMMAND** mode menu blocks.

A title or command can be typed using the HP-HIL keyboard. Pressing **(Return)** or **(Enter)** will terminate the title or command, and the HP 70900A/B local oscillator source will respond.

Rear-Panel Connectors and Address Switches

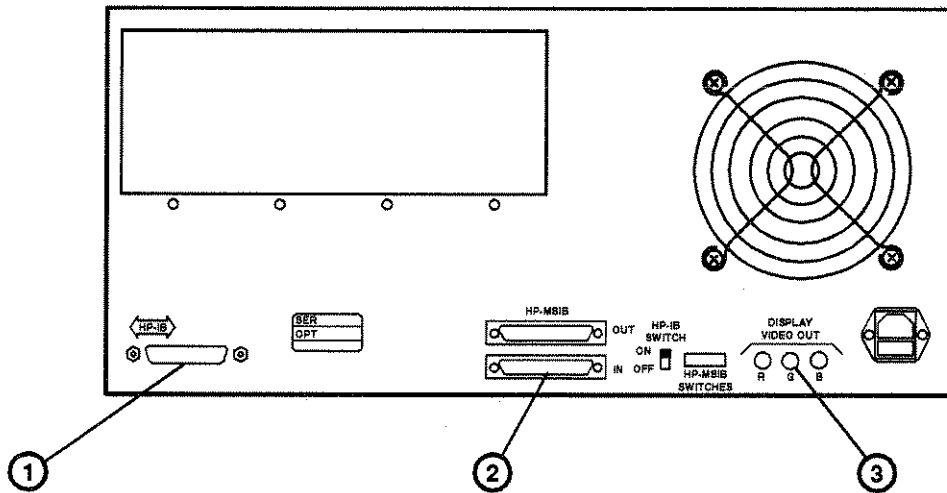

backoone.odr

HP 70004A Color Display Rear-Panel Connectors

- | | | |
|---|-------|---|
| 1 | HP-IB | The Hewlett-Packard Interface Bus (HP-IB) provides IEEE-488 communication between the display, controllers, other HP-IB instruments, and each module installed in the display that implements HP-IB. |
| 2 | MSIB | The Modular System Interface Bus (MSIB) is the high-speed digital bus used by master and slave modules and other elements for exchanging control information and data. |
| 3 | RGB | The RGB monitor output provides a red, green, and blue output, with sync on green (75 Ω impedance, 1 Vpp, 25 kHz horizontal sweep frequency, 60 Hz vertical sweep frequency, and 400 horizontal lines). |

RCA to BNC adapters (HP part number 1250-1853) are available for BNC connections.

Rear-Panel Connectors and Address Switches

A display section is an independent element. When you set the HP-IB switch to 0 (OFF), the HP-IB interface for the *display section only* is turned off. Modules plugged into the display are unaffected and may still talk to each other through HP-IB or communicate over the rear panel HP-IB connector. The HP-IB switch does not disrupt instrument operation.

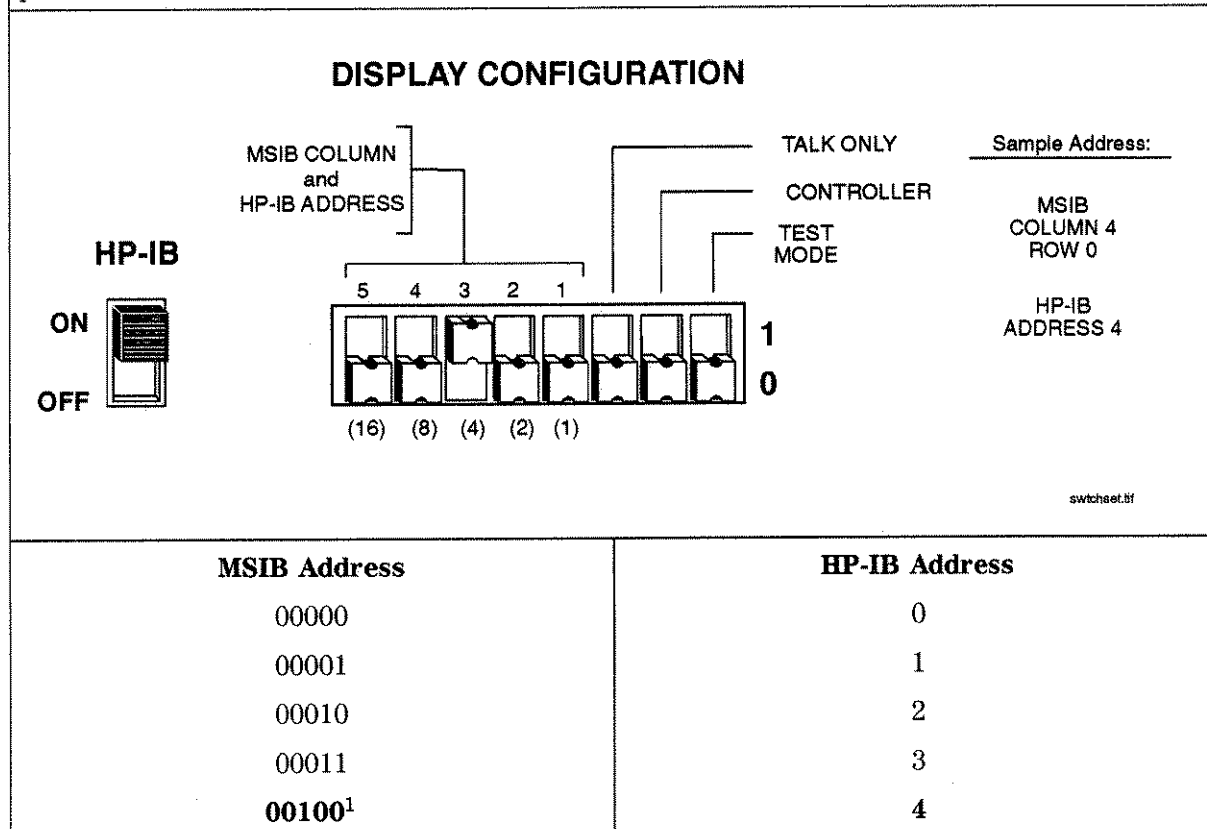

¹ The display section's MSIB COLUMN address is factory-preset to 4 and may be changed, but the display's MSIB ROW address is permanently set to 0.

HP-IB ON/OFF

The HP-IB ON/OFF switch is used to turn on or off the display's HP-IB without disrupting instrument operation.

A1–A5

These address switches set the MSIB column address, which is also the default HP-IB address. Setting the HP-IB address from the front panel overrides the rear panel HP-IB address switch setting.

Note that address switches A6–A8 do not exist on the HP 70004A color display so that the MSIB row address is always 0.

TALK ONLY

When you set the Talk Only switch to 1 (ON), the display can talk on HP-IB without requiring a reply. This accommodates, for example, listen-only plotters. For normal operation, set switch to 0 (OFF).

SYSTEM CONTROLLER

When you set the System Controller switch to 1 (ON) the display may function as a system controller on HP-IB during printer or plotter dumps.

Rear-Panel Connectors and Address Switches

TEST MODE

When you set the Test Mode switch to 1 (ON), the display goes into a special test mode at power-up. For normal operation, set this to 0 (OFF).

Operating/Local MSIB Operation

Summary In this chapter you will learn about:

- Configuring your system and assigning instruments (modules) to different windows.
 - Changing the color settings and system clock time used by the display.
 - Printing and plotting display screens.
 - Saving and retrieving information.
-

This chapter prepares you for your first steps in using the HP 70004A color display in a system. You will learn how to build or stack windows on your display and assign the keyboard or display or both to an instrument by using various softkey menus. Then, you will learn how to change display colors and set the system clock. Finally, you'll learn how to produce outputs on a printer or plotter, and how to save and retrieve information using external mass storage devices such as HP-IB disk drives and RAM cards.

Configuring Display Windows	4-2
Configuring Display Colors	4-16
Configuring the Display Clock	4-20
Printing and Plotting	4-22
Selecting and Saving to External Mass Storage Devices	4-30
Miscellaneous User Tasks	4-38

Configuring Display Windows

In this section, you will learn how to build or stack windows on your display and assign the keyboard or display or both to an instrument by using various softkey menus. After you have configured your system, you can view your configuration and then start using it, or purge it and start over.

To build 1, 2, or 4 windows on the display	4-3
To stack 2 or 4 windows on the display	4-4
To build custom sized windows on the display	4-5
To establish a link to an instrument	4-6
To access a window over HP-IB	4-6
To view column and row addresses in the address map	4-7
To assign the display (only) to an instrument	4-8
To assign the keyboard (only) to an instrument	4-8
To assign both the display and keyboard to an instrument	4-9
To set the HP-IB address of a master module	4-9
To set the HP-IB/MSIB address of the HP 70004A color display	4-10
To show system configurations	4-11
To save a system configuration	4-12
To recall a system configuration	4-13
To purge a window configuration	4-14
To purge configuration registers	4-14
To clear the display	4-15

To build 1, 2, or 4 windows on the display

1. Press **DISPLAY** **Config Display** **build window**
2. Press **BUILD 1 WINDOW** or **BUILD 2 WINDOWS** or **BUILD 4 WINDOWS**
3. Press **assign window**.
4. Press **MSIB COLUMN** to assign an instrument to the currently selected window.

If you have more than one window built, you can also assign an instrument to a different window by selecting a number between 1 and 4 from the keypad or HP-HIL keyboard and pressing **ENTER**. (If you make an error, press **←** to return to the previous menu. Repeat your selection with the corrected entry if necessary.)

The window selected, if currently defined, is highlighted with a green border; if you built 2 windows (using **BUILD 2 WINDOWS**) and tried to assign an instrument to window 3 or window 4, the assignment would not be accepted because only windows 1 and 2 are available for assignment.

5. Rotate the front panel knob (or use the **△** or **▽** keys, or the numeric keypad) to enter the column number of the instrument you are interested in assigning to the current window.
6. Press **EXECUTE**.
7. If you selected **BUILD 2 WINDOWS** or **BUILD 4 WINDOWS**, repeat steps 3 through 6 above to assign instruments to each of the remaining windows.

A window is a user-defined portion of the HP 70004A color display that is set aside for a single instrument (master) to display information.

Each instrument can only be assigned to one window at a time because each instrument can establish only one display link with the HP 70004A color display; in order for an instrument to be reassigned to a new window, all previous display links must first be broken; this is done automatically with the use of **assign window**.

If you are having problems finding an instrument to assign to a window, refer to the section "To view column and row addresses in the address map".

Note

In both *build* and *stack* functions, if windows remain unfilled, the display will search the address map for other instruments on row 0 to fill the windows. The windows are filled in order (1-4) and the modules are assigned in order of address (0-30). There is an exception to this rule. If a window has been assigned to a module and that module has been removed from the system, no attempt will be made to find another module for that window unless that window has first been purged using **purge window** or **PURGE ALL**.

Configuring Display Windows

To stack 2 or 4 windows on the display

1. Press **DISPLAY** **Config Display** **build window**.
2. Press **STACK 2 WINDOWS** or **STACK 4 WINDOWS**.
3. Press **assign window**.
4. Press **MSIB COLUMN** to assign an instrument to the currently selected window.

You can also assign an instrument to a different window by selecting a number between 1 and 4 from the keypad or HP-HIL keyboard and pressing **ENTER**. (If you make an error, press **←** to return to the previous menu. Repeat your selection with the corrected entry if necessary.)

The window selected, if currently defined, is highlighted with a green border; if you built 2 windows (using **STACK 2 WINDOWS**) and tried to assign an instrument to window 3 or window 4, the assignment would not be accepted because only windows 1 and 2 are available for assignment.

5. Rotate the front panel knob (or use the **△** or **▽** keys, or the numeric keypad) to enter the column number of the instrument you are interested in assigning to the current window.
6. Press **EXECUTE**.
7. Repeat steps 3 through 6 above to assign instruments to each of the remaining windows.

A window is a user-defined portion of the HP 70004A color display that is set aside for a single instrument (master) to display information.

Each instrument can only be assigned to one window at a time because each instrument can establish only one display link with the HP 70004A color display. In order for an instrument to be reassigned to a new window, all previous display links must first be broken; this is done automatically with the use of **assign window**.

If you are having problems finding an instrument to assign to a window, refer to the section "To view column and row addresses in the address map".

Note In both *build* and *stack* functions, if windows remain unfilled, the display will search the address map for other instruments on row 0 to fill the windows. The windows are filled in order (1-4) and the modules are assigned in order of address (0-30). There is an exception to this rule. If a window has been assigned to a module and that module has been removed from the system, no attempt will be made to find another module for that window unless that window has first been purged using **purge window** or **PURGE ALL**.

To build custom sized windows on the display

1. Press **DISPLAY** **DISPLAY PRESET** **Config Display**.
2. Press **build window** **custom windows** **SELECT WINDOW**.
3. Designate the number of the window that you would like to build by selecting a number between 1 and 4 from the keypad or HP-HIL keyboard and pressing **ENTER**; the default window being built is window 1. (If you make an error, press **←** to return to the previous menu. Repeat your selection with the corrected entry if necessary.)
4. Press **DEFAULT CORNERS** **SET Y-min**.
5. Using the display knob, select a position for the bottom of your custom window.
For example, to create a custom window over the top half of the display, place the bottom of the window in the center screen and press **EXECUTE**. (You can specify the approximate center of the screen by entering 191 through the numeric keypad.)
6. Press **←** **assign window**.
7. Press **MSIB COLUMN** to assign an instrument to the currently selected window.
If you have more than one window built, you can also assign an instrument to a different window by selecting a number between 1 and 4 from the keypad or HP-HIL keyboard and pressing **ENTER**. (If you make an error, press **←** to return to the previous menu. Repeat your selection with the corrected entry if necessary.) The window selected, if currently defined, is highlighted with a green border. If you built only 1 custom window and tried to assign an instrument to window 2, 3, or 4, the assignment would not be accepted because only window 1 is available for assignment; you would have to build additional windows.
8. Rotate the front panel knob (or use the **△** or **▽** keys, or the numeric keypad) to enter the column number of the instrument you are interested in assigning to the current window.
9. Press **EXECUTE**.
10. Repeat steps 2 through 9 above to build additional custom windows.
Up to four custom defined windows can be built and assigns instruments in each configuration.

A window is a user-defined portion of the screen that is set aside for a single instrument to display information. Allowable custom window dimensions are from 0 to 383 along the y-axis and 0 to 1023 along the x-axis.

The window being defined has a green border, the old window has a gray border, and the default window (selected by **DEFAULT CORNERS**) has a red border.

Configuring Display Windows

To establish a link to an instrument

1. Press **DISPLAY** **NEXT INSTR**.

If the display does not have a link to an instrument, it will look for the instrument with the lowest column address on the MSIB and allocate the entire screen and the 14 softkeys to that instrument.

If a link already exists, the display will select the instrument with the next higher address (following the sequence... 28, 29, 30, 0, 1, 2...).

2. Continue to press the **▲** (or **NEXT INSTR** again) or **▼** keys to select the instrument with the next higher or next lower address.
3. Press **USER** or **MENU** and use the appropriate softkeys.

Under **USER**, you may have softkeys for DLPs and under **MENU**, you may have softkeys that are specific to the module that you selected. For information on using softkeys, refer to the user guide for your specific module.

The information displayed, once the display is given to an instrument, depends on the specific instrument selected. Since **NEXT INSTR** only establishes communication links between the display and the instrument, most instrument settings are not affected when an instrument is selected; however, any previously defined display windows are erased.

To access a window over HP-IB

1. Press **DISPLAY** **Address Map**.
2. Press **assign window**.
3. Select a window by entering a number between 1 and 4 from the keypad or HP-HIL keyboard and pressing **ENTER**. (If you make an error, press **←** to return to the previous menu. Repeat your selection with the corrected entry if necessary.)
4. Press **HP-IB EXECUTE**.

The window will have the HP-IB address of the display. (See **Address Map** to determine the HP-IB address of the display.)

Only one display window, at a given time, can be assigned to HP-IB.

HP-IB can also operate without an explicitly defined window, since it automatically receives window 5 at power-up; if not assigned one, no HP-IB window appears in **SHOW CONFIG**.

Configuring Display Windows

To assign the display (only) to an instrument

1. Press **DISPLAY** **Address Map** **ADJUST COLUMN**.
2. Turn the knob until the rectangle encompasses an instrument on ROW 0.
3. Press the **ASSIGN DISPLAY** softkey.
The screen will be immediately allocated to that module. If the module is ready to put out trace information, the information will be displayed.
4. To assign the display back to an instrument, either repeat this procedure with the original instrument selected from the address map or press **NEXT INSTR** until the desired instrument is selected.

ASSIGN DISPLAY assigns the whole screen to a particular instrument, even though the keyboard may be assigned elsewhere.

This allows the user to view the trace output from one instrument on the display, while controlling a different instrument with the keyboard. The two display resources, the keyboard and the display screen, can be allocated separately.

To assign the keyboard (only) to an instrument

1. Press **DISPLAY** **Address Map** **ADJUST COLUMN**.
2. Turn the knob until the rectangle encompasses an instrument on ROW 0.
3. Press **ASSIGN KEYBD** **MENU**.
The keyboard will be immediately allocated to that module.
4. To assign the keyboard back to an instrument, either repeat this procedure with the original instrument selected from the address map or press **NEXT INSTR** until the desired instrument is selected.

The **ASSIGN KEYBD** softkey is used to allocate the keyboard to a specific module. The keyboard can then be used to control the instrument settings.

The keyboard and the screen can be allocated separately. **ASSIGN KEYBD** links the keyboard with an instrument, but does not necessarily display any trace data from that instrument. Because of this, the softkeys may not correspond to the instrument display shown.

Only a master module such as the HP 70900B local oscillator source can receive the keyboard. Attempts to allocate the keyboard to slave modules will result in an error.

Use the **INSTR** key as the primary way of transferring the keyboard between instruments once they are assigned to windows. When the **INSTR** key is pressed, the display assigns colored borders to the currently defined windows. Near each window a softkey containing the first seven characters in the module's model number and address (row and column) are displayed in inverse video in the same color as the border. If a labeled softkey is pressed, the keyboard is offered to that window's instrument. If the instrument accepts the keyboard it will put up its menu keys, as though the **MENU** key had been pressed.

To assign both the display and keyboard to an instrument

1. Press **DISPLAY** **Address Map** **ADJUST COLUMN**.
2. Turn the knob until the rectangle encompasses an instrument on ROW 0.
3. Press **ASSIGN BOTH** **MENU**.

ASSIGN BOTH establishes contact between the display and a specific instrument, and then allocates the screen and keys to the module currently highlighted by the rectangle in the address map.

ASSIGN BOTH differs from **NEXT INSTR**:

ASSIGN BOTH requires that a particular module be specified while **NEXT INSTR** selects an instrument on its own by scanning ROW 0 of the address map until it finds a master module.

Both softkeys, however, disconnect any links between the display and any other instruments, and both destroy any existing windows in the display.

To set the HP-IB address of a master module

1. Press **DISPLAY** **Address Map** **ADJUST COLUMN**.
2. Turn the knob until the rectangle encompasses an instrument on ROW 0 that you want to set the HP-IB address on.
3. Press the **HP-IB ADDRSET**.
4. Enter the new address using the keypad. (For example, select **2**, **0**, and **ENTER**. The HP-IB address of the module should immediately change to 20.)

The **HP-IB ADDRSET** softkey changes the HP-IB address of any instrument currently on HP-IB if that instrument will permit it.

All modules that have an HP-IB address must be master modules and must be located on ROW 0; slave modules cannot have HP-IB addresses.

Some HP 70000 Series modular measurement system elements show an HP-IB address on the address map even though the element is disabled (by the HP-IB enable switch) and cannot communicate on HP-IB. Modules show that they are disabled by replacing their HP-IB address with the word NO in the address map; they show HP-IB NO which means that their HP-IB enable switch is in the OFF position. (For information on setting the HP-IB enable switch for a particular module, refer to the installation and verification manual for that module.) The HP-IB enable switch for the HP 70004A color display is located on the rear panel. For information on setting the address switches of the HP 70004A color display, refer to "Step 5. Setting the MSIB and HP-IB Address" in Chapter 1.

Upon power-up, the HP-IB addressing is handled differently by different elements. The display can be configured to have a power-up HP-IB address of either the MSIB column address or the most recent HP-IB address given to the display with the **HP-IB ADDRSET** key.

Configuring Display Windows

To set the HP-IB/MSIB address of the HP 70004A color display

1. Press **DISPLAY** **Address Map** **ADJUST COLUMN**.
2. Turn the knob so the rectangle stops on the module that you want to set the HP-IB address on; in this example, select the HP 70004A color display.
3. Press the **HP-IB ADDRSET**.
4. Enter the new address using the keypad.

(For example, select **2**, **0**, and **ENTER**. The HP-IB address of the module should immediately change to 20.)

The HP 70004A color display's MSIB COLUMN address is factory-preset to 4 and may be changed, but the display's MSIB ROW address is permanently set to 0.

Setting the MSIB COLUMN address of the display, specifies both the MSIB address and the HP-IB address of the HP 70004A color display.

For information on setting the address switches of the HP 70004A color display, refer to "Step 5. Setting the MSIB and HP-IB Address" in Chapter 1.

To show system configurations

1. Press **DISPLAY** **Config Display** **SHOW CONFIG**.
2. In addition to the current configuration that is shown, use the **△** and **▽** keys to view Configuration Registers 1 through 4. These other configuration registers can be loaded with information using **SAVE CONFIG**. (Refer to the section "To save a system configuration".)

The display has six resources that it can assign to any of several HP 70000 Series elements: these resources consist of a screen composed of up to four windows, plus a fifth window reserved for a controller on HP-IB, and one keyboard. The fifth window is invisible; it does not show up when using **SHOW CONFIG**.

SHOW CONFIG not only brings up the current configuration of the display, but also can show four other complete display configurations. These configurations reside in continuous-memory registers, so they will be recalled even if the power had been turned off.

SHOW CONFIG displays the following information:

- each window number (windows 1 through 4)
- whether or not a window is defined in the configuration being viewed; if a window is not defined in the configuration being viewed, it will display the word: **undefined**
- if a window is defined, then the following is also displayed:
 - the instrument that the keyboard is assigned to
 - the abbreviated name of the instrument that is assigned to each window; the abbreviated name refers to the instrument that can write to a given window.
 - following the abbreviated name is the MSIB ROW and COLUMN address
 - below the abbreviated name are the X and Y dimensions of each defined window
- Up to four windows can be defined in each configuration. While looking at the "Example Current Configuration" shown below, notice that only windows one and two are defined, while windows three and four are undefined. In addition, you can also determine that the keyboard is assigned to window one, the HP 70900B local oscillator source is assigned to window one which is at MSIB address ROW 0 and COLUMN 18, and the HP 70700A digitizer is assigned to window two which is at MSIB address ROW 0 and COLUMN 7.

	A	(75) 08:53:22 JUL 26, 1989	DISP
		CURRENT CONFIGURATION	SHOW
Main		Window 1	CONFIG
		Keyboard: 70900B,Lo/Ctrl (0, 18)	
Hard		Xmin,Ymin: 112, 16	SAVE
Copy		Xmax,Ymax: 911, 199	CONFIG
Mass		Window 2: 70700A,DIGITIZER (0, 7)	RECALL
Storage		Xmin,Ymin: 112, 200	CONFIG
		Xmax,Ymax: 911, 303	
Adjust		Window 3: undefined	
Color		Window 4: undefined	
Config			build
Display			window
Address			assign
Map			window
Misc			purge
			window

USE ↑/↓ TO SHOW PREV/NEXT CONFIGURATION

Example of a Current Configuration

Configuring Display Windows

To save a system configuration

1. Press **DISPLAY** **Config Display**.
2. Select a number between 1 and 4 from the keypad or HP-HIL keyboard and press **ENTER**.
(If you make an error, press **←** to return to the previous menu. Repeat your selection with the corrected entry if necessary.)
3. Press **SAVE CONFIG**.

This saves the current configuration in one of the four configuration registers (with up to four windows per configuration). The current configuration will also be retained in battery-backed RAM if the power is turned off.

To recall a system configuration

1. Press **DISPLAY** **Config Display**.
2. Select a number between 1 and 4 from the keypad or HP-HIL keyboard and press **ENTER**. (If you make an error, press **←** to return to the previous menu. Repeat your selection with the corrected entry if necessary.)
3. Press **RECALL CONFIG**.

This recalls a previously stored configuration that is saved in one of the four configuration registers (with up to four windows per configuration).

Example using **SAVE CONFIG** and **RECALL CONFIG**:

In this example, you save the current configuration in a configuration register, select a new instrument, use the new instrument to perform a task, and then return to the saved configuration.

1. Save the current configuration in a configuration register.
 - a. Press **DISPLAY** **Config Display**.
 - b. Select a number between 1 and 4 from the keypad or HP-HIL keyboard and press **ENTER**. (If you make an error, press **←** to return to the previous menu. Repeat your selection with the corrected entry if necessary.)
 - c. Press **SAVE CONFIG**.
2. Press **DISPLAY** **NEXT INSTR**.

Continue to press the **△** (or **NEXT INSTR** again) and **▽** keys to select the instrument with the next higher or next lower address until you have selected a desired instrument.
3. Press **USER** or **MENU** and use the appropriate softkeys for the instrument you selected.
4. When finished with the selected instrument, return to the previously saved configuration.
 - a. Press **DISPLAY** **Config Display**.
 - b. Select a number between 1 and 4 from the keypad or HP-HIL keyboard and press **ENTER**. (If you make an error, press **←** to return to the previous menu. Repeat your selection with the corrected entry if necessary.)
 - c. Press **RECALL CONFIG**.

Your previously saved configuration should be restored to the state that it was prior to performing step 2 of this example.

Configuring Display Windows

To purge a window configuration

1. Press **DISPLAY** **Config Display** **purge window**.
2. Press **EXECUTE** or select a number between 1 and 4 from the keypad or HP-HIL keyboard and press **ENTER** to specify a particular window to be purged. (If you make an error, press **←** to return to the previous menu.) A green border outlines the selected window that is to be purged.

You can also press **PURGE ALL** to purge the stored information from all four windows at once.

Note that **PURGE ALL** does not purge information that is stored in Configuration Register 1 through 4 all at once, it only purges the information for windows 1 through 4 that are in the current configuration register that is selected; each of the four configuration register (Configuration Register 1 through 4) must be specifically selected. (Refer to "To purge configuration registers".)

To purge configuration registers

1. Press **DISPLAY** **Config Display** **RECALL CONFIG**.
2. Select a number between 1 and 4 from the keypad or HP-HIL keyboard and press **ENTER**. The number that is selected designates the desired configuration register (Configuration Register 1, 2, 3, or 4) from which you will be purging information.
3. Press **purge window**.
4. Press **EXECUTE** or select a number between 1 and 4 from the keypad or HP-HIL keyboard and press **ENTER** to specify a particular window to be purged from the selected configuration. (If you make an error, press **←** to return to the previous menu.) A green border outlines the selected window that is to be purged.

You can also press **PURGE ALL** to purge the stored information from all four windows at once.

Note that **PURGE ALL** does not purge information that is stored in Configuration Register 1 through 4 all at once, it only purges the information that is in a selected configuration register; each configuration register must be specifically selected with the above process.

To reestablish a display link, press either **NEXT INST** (this causes ROW 0 to be scanned for master modules) or create a new window link using one of the following procedures:

- To build 1, 2, or 4 windows on the display
- To stack 2 or 4 windows on the display
- To build custom sized windows on the display

To clear the display

1. Press **DISPLAY** **DISPLAY PRESET**.

This key sequence clears the display screen, all errors, the HP-IB output buffer, and assigns the entire display screen to the last instrument controlled by the keyboard. A display preset is different from an instrument preset. An instrument preset would place all of an instruments settings to their default (preset) value and would not affect the configuration of the display.

Configuring Display Colors

Display colors have been preset with a set of default colors which you may choose to change in order to suit environmental needs, individual preferences, or to accommodate color-deficient vision.

The display's default colors have been chosen to maximize your ability to comfortably discern the difference between on-screen colors. We recommend these colors for normal use. They provide a suitable contrast that is easy to view for long periods of time.

The HP 70004A color display can display text and graphics in up to 16 simultaneous colors, selectable from a palette of 4096 colors.

To customize display colors	4-17
To set the display color to monochrome	4-17
To change the monochrome display to different shades of green	4-18
To change the special color elements	4-18
To save custom display colors	4-18
To recall custom display colors	4-19
To return to default display colors	4-19
To adjust the brightness of the display	4-19

To customize display colors

The following steps will change the background element color.

1. Press **DISPLAY** **Adjust Color** **edit colors**.
2. Press **BACKGROUND** and rotate the knob clockwise and counter-clockwise; you should notice that the hue changes.
3. Press **RGB**.
4. Press **GREEN** and use the **△** and **▽** keys to change the color.
5. Press **BLUE** and use the **△** and **▽** keys to change the color.
6. Press the **HSL** softkey and rotate the RPG in either direction.

Note To return to the default color settings, press **UNDO**.

The **BACKGROUND** and **KEY LABELS** softkeys always appear in the **edit colors** menu. The instrument that owns the display's keyboard may generate all other key labels. In those cases when an instrument does not generate key labels, **COLOR 1** through **COLOR 10** will appear on the menu. Each key in the **edit colors** menu reflects the element color assigned to that key. Keys whose associated colors are very dim appear surrounded by an inverse video block.

To set the display color to monochrome

1. Press **DISPLAY** **Adjust Color** **MONOCHROME**.

MONOCHROME sets the display screen to green monochrome.

The monochrome display uses different shades of green; up to ten different shades can be specified. This is especially useful for driving external monochrome monitors from the green video output available through the rear panel. For a listing of the default monochrome colors, refer to Table 5-5 and for information on driving external monitors, refer to "Understanding RGB Video Outputs and Their Use" in Chapter 9.

Configuring Display Colors

To change the monochrome display to different shades of green

1. Press **DISPLAY** **Adjust Color** **MONOCHROME**.
2. Press **edit colors** **Color X** (where X is 1, 2, 3, ... 10).
3. Press **HSL/RGB** **GREEN**.
4. Rotate the front panel knob (or use the **▲** or **▼** keys, or the numeric keypad) to select the desired shade of green. The shade can be adjusted from 0 to 15, with 0 being virtually off and 15 full intensity.

MONOCHROME sets the display screen to green monochrome.

The monochrome display uses different shades of green; up to ten different shades can be specified. This is especially useful for driving external monochrome monitors from the green video output available through the rear panel. For a listing of the default monochrome colors, refer to Table 5-5 and for information on driving external monitors, refer to "Understanding RGB Video Outputs and Their Use" in Chapter 9.

To change the special color elements

1. Press **DISPLAY** **Adjust Color** **special colors**.
2. Press either **VISION ENHNC 1** or, **VISION ENHNC 2** or, **OPTICAL FILTER**.

The special colors built into vision-enhanced displays 1 and 2 accommodate most color-deficient vision problems. The optical filter was designed to accommodate the use of protective goggles while viewing lasers.

Refer to Table 5-6, Table 5-7, and Table 5-8 for values of special color elements.

To save custom display colors

1. Press **DISPLAY** **Adjust Color** **SAVE COLORS**.
2. Select a number between 1 and 4 from the keypad or HP-HIL keyboard and press **ENTER**.

The number that is selected designates one of four color-save registers where the on-screen display colors are saved.

Note In ROM Version 7.0 the **Save Colors** function uses *volatile* memory. Colors saved will be lost when the power is turned off.

In ROM Version 7.01 and greater the **Save Colors** function uses *non-volatile* memory and colors saved will be retained when the power is turned off.

To determine the current ROM version, refer to the section "To view current display information (firmware, address, model, etc.)".

To recall custom display colors

1. Press **DISPLAY** **Adjust Color** **RECALL COLORS**.
2. Select a number between 1 and 4 from the keypad or HP-HIL keyboard and press **ENTER**.

The number that is selected designates one of four color-save registers where the on-screen display colors were saved with **SAVE COLORS**.

Sometimes an instrument module will modify the colors on the screen to enhance a measurement. An example of this can be seen in the HP 70900B local oscillator source's **Persist On/Off** menu. When the screen is in this state and the user enters the **Edit Colors** menu, the screen will return to the user's color palette, canceling the module's colors. If you wish to edit one of these module-modified color palettes, you must first **SAVE** it, then **RECALL** it; this enters it into the user's palette and then it may be edited.

To return to default display colors

1. Press **DISPLAY** **Adjust Color** **DEFAULT COLORS**.

This sets all the display screen attributes to the factory-defined colors.

For a listing of the default colors, refer to Table 5-4.

To adjust the brightness of the display

1. Press **DISPLAY** **INTEN ADJUST**.

INTEN ADJUST allows the user to change the intensity of the display screen. Intensity is incrementally adjustable from 0 to 19 in steps of 1.

Note The 0 intensity setting may not be completely OFF. If the display is turned OFF with the intensity set to less than 9, the intensity will reset to 9 at power-up to ensure that the screen will not be too dim to see.

Configuring the Display Clock

The HP 70004A color display will work normally without the clock being set to any particular time, but it is a good idea to set the clock to correspond to your local time so that any information that you store or print is given a correct time stamp (time stamp shows: hours, minutes, seconds, month, day, and year).

To select US or European clock style	4-20
To set the display clock	4-21

To select US or European clock style

1. Press **DISPLAY** **Misc** **clock**.
2. Press **US/EURO**.

US/EURO allows the user to set the clock in either US or European format:

US Format: JUL 6, 1997 (Month-Day-Year)

European Format: 06.07.1997 (Day-Month-Year)

To set the display clock

1. Press **DISPLAY** Misc **clock**.
2. Press **CLOCK DISPLAY** Set Clock.
3. Enter your current date:

EXAMPLE: Change the date to DEC 25, 1997.

- a. Press **MONTH** 1 2 **ENTER**.
- b. Press **DAY** 2 5 **ENTER**.
- c. Press **YEAR** 1 9 9 7 **ENTER**.

4. Enter your current time:

EXAMPLE: Change the time to 7:35:21 AM.

- a. Press **HOUR** 7 **ENTER**.
- b. Press **MINUTE** 3 5 **ENTER**.
- c. Press **SECOND** 2 1 **ENTER**.

EXAMPLE: Change the time to 7:35:21 PM.

- a. Press **HOUR** 19 **ENTER**.
- b. Press **MINUTE** 3 5 **ENTER**.
- c. Press **SECOND** 2 1 **ENTER**.

CLOCK DISPLAY switches the real-time clock readout ON and OFF.

When in the default state, ON (indicated by the underlined key label), the real-time clock readout appears in the display's status information area; the status information area is on the top of the HP 70004A color display's screen.

Once set, the HP 70004A color display automatically keeps track of the current date and time, even while it is turned off. *All clock inputs are numerical.* Enter the numbers with either the knob, step keys, or numerical keypad. Exit by pressing the **←** key or any other key.

RUN/STOP switches the clock between stopped and running to aid in synchronizing the clock.

Printing and Plotting

To print to an HP LaserJet Series printer	4-23
To print to an HP-IB printer	4-24
To print to an HP PaintJet printer	4-25
To print to an HP ThinkJet printer	4-26
To set the printer address of a non-MMS printer	4-27
To set the printer address of an MMS printer	4-27
To set the plotter configuration	4-28
To set the plotter address of a non-MMS plotter	4-28
To set the plotter address of an MMS plotter	4-29

To print to an HP LaserJet Series printer

Note Because color printers introduced a new standard not supported by the HP 70004A color display, the following information applies only to black and white printers.

1. If system controller is connected, release the system controller from the HP-IB.

When trying to print to an HP-IB printer, the system controller can not have control of the HP-IB; you must either physically remove the system controller from the HP-IB, or you can leave it connected and enter a command from the system controller's keyboard that will release it from the HP-IB.

For example, if you are programming in Rocky Mountain Basic (RMB), the system controller can be released from the HP-IB by typing the following at the RMB prompt: send 7; unl unt data and then press **Enter**; this should release the HP-IB so that the HP 70004A color display screen can be copied to an HP-IB printer.

2. Press **PAINTJT COLOR** or **THINK JET** as a print driver.
3. Select whether or not to print with high resolution by selecting **HIGH RESLN** on or off.

Depending on the model of HP LaserJet that you are printing to, selecting high resolution (with **HIGH RESLN**) will cause your printout to be a smaller size than without high resolution mode on.

4. Select whether to include the menu keys along with the printed display by selecting **KEY COPY** on or off.

If **KEY COPY** is selected, the menu keys printed are the last ones displayed that were associated with a selected instrument. Menu keys available under **DISPLAY** can be printed using the **KEYCOPY OFF/DSP** key in the **service modes** menu.

5. Obtain the instrument display you want to print by using the menu keys in the **MENU** or **USER** menus.
6. Once you have obtained the instrument display that you want to print, press the **PRINT** key; the printing process will begin immediately.

Printing can be halted by pressing any front panel key on the display during the print sequence. Once the printing begins, the screen will be frozen until the data transfer to the printer is complete.

Because most printers that are currently produced do not have Bi-tronics parallel connectors (HP-IB) on them, you must connect most printers as non-MMS devices by using an interface converter.

When using an interface converter, an HP-IB cable (HP 10833A) is connected from the HP-IB connector on the rear of the HP 70004A color display to one side of the interface converter. There are a number of different interface converters made by Intelligent Interfaces Inc. (ITEL) that will work. (Refer to Table 1-2). The other side of the interface converter is connected to a Centronics (parallel) peripheral interface cable (HP 92284A) which is connected directly to a printer.

Printing and Plotting

To print to an HP-IB printer

Note To follow this example, you may need to enter the address of your printer into the Hard Copy Menu and specify whether the menu keys are to be printed. (Refer to **printer address** and **KEY COPY** under "**DISPLAY Hard Copy**" in Chapter 5.)

1. If system controller is connected, release the system controller from the HP-IB.

When trying to print to an HP-IB printer, the system controller can not have control of the HP-IB; you must either physically remove the system controller from the HP-IB, or you can leave it connected and enter a command from the system controller's keyboard that will release it from the HP-IB.

For example, if you are programming in Rocky Mountain Basic (RMB), the system controller can be released from the HP-IB by typing the following at the RMB prompt: send 7; unl unt data and then press **(Enter)**; this should release the HP-IB so that the HP 70004A color display screen can be copied to an HP-IB printer.

2. Enter the address of your HP-IB printer via the **printer address** key.
3. Select whether to include the menu keys along with the printed display by selecting **KEY COPY** on or off.

If **KEY COPY** is selected, the menu keys printed are the last ones displayed that were associated with the instrument, not the display element. Menu keys available under **(DISPLAY)** can be printed using the **KEYCOPY OFF/DSP** key in the **service nodes** menu.

4. Obtain the instrument display you want to print by using the menu keys in the **(MENU)** or **(USER)** menus.
5. Once you have obtained the instrument display that you want to print, press the **(PRINT)** key; the printing process will begin immediately.

Printing can be halted by pressing any front panel key on the display during the print sequence. Once printing begins, the screen will be frozen until the data transfer to the printer is complete.

Compatibility: the raster print-dump process works with HP raster-format printers (dot-matrix) that can accept printer dumps of at least 384 lines by 512 points; for example, the HP 2673A printer and the HP 2225A ThinkJet printer have this capability. (The **HI RES ON/OFF** function requires a capability of 384 lines by 1024 points.) Most of the printers that work with the HP 9000 Series 200/300 controller will work with the HP 70000 Series modular measurement system.

To print to an HP PaintJet printer

Note The term **high resolution** that is used throughout this procedure refers to 180 dpi resolution printer dumps.

1. Press **(DISPLAY)** **Hard Copy printer config.**
2. Press **PAINTJT COLOR.**

PAINTJT COLOR is the default printer mode. You may also press **PAINTJT BLACK** for a one-color (black) output to an HP PaintJet printer.

3. Press **HIGH RESLN** (switched on), for a high resolution color HP PaintJet output.

When high resolution is selected, only six colors are available, otherwise ten colors are available. See Table 5-1 for the HP PaintJet high-resolution and low-resolution color mapping. The higher resolution obtainable with **HIGH RESLN** is available only on raster **(PRINT)** operations.

4. Press **(PRINT)**.

Depending on your selection above, this performs either a one-color (black) output, a six color high resolution output (180 dots per inch), or a ten color low-resolution output (90 dots per inch).

The colors printed on the PaintJet are a function of the *color number* of each item on the screen, not the *color* of each item on the screen. The PaintJet's colors do not change when the on-screen colors are changed using "Configuring Display Colors".

HIGH RESLN reprograms the printer to hold more dots per line. The display is 1024 dots across the screen, and in high resolution mode, all 1024 dots are dumped. With high resolution off, the 1024 dots are consolidated into 512 dots. Some information is lost this way, but the printer dumps are faster. Since the HP 70004A color display does not remember the initial mode of a printer before a high resolution dump, the printer is left in high resolution mode after a high resolution dump is performed.

When making high-resolution prints, the printing operation will be slower than usual. This is because the printer must place more dots on each line.

Printing and Plotting

To print to an HP ThinkJet printer

Note The term **high resolution** that is used throughout this procedure refers to 180 dpi resolution.

1. Press **DISPLAY** **Hard Copy printer config.**
2. Press **THINK JET.**
3. Press **HIGH RESLN** (switched on), for a printer output that is 1024 dots wide and consists of the entire 1024 dot resolution of the display, or leave **HIGH RESLN** unselected (switched off) for a printer output that is 512 dots wide and consists of 512 dot resolution of the display.
4. Press **PRINT.**

This performs a black and white output to an HP ThinkJet printer with either 1024 or 512 dot resolution.

Both the HP ThinkJet and HP PaintJet printers can accommodate 1024 points per line.

Not all raster printers can accommodate 1024 points per line. Some older printers have a line width less than 1024 points; do *not* use **HIGH RESLN** with these older printers.

It is not necessary to distinguish between **PAINTJT BLACK** and **THINK JET** printer dumps except when a **HIGH RESLN** printer dump is selected. This is because of differences in the printer control sequences that are only important for 180 dpi resolution printer dumps.

The higher resolution obtainable with **HIGH RESLN** is available only on raster print operations.

HIGH RESLN reprograms the printer to hold more dots per line. The display is 1024 dots across the screen, and in high resolution mode, all 1024 dots are dumped. With high resolution off, the 1024 dots are consolidated into 512 dots. Some information is lost this way, but the printer dumps are faster. Since the HP 70004A color display does not remember the initial mode of a printer before a high resolution dump, the printer is left in high resolution mode after a high resolution dump is performed.

When making high-resolution prints, the printing operation is slower because the printer must place twice the dots on each line than when in normal mode.

To set the printer address of a non-MMS printer

1. Press **DISPLAY** **Hard Copy printer address**.
2. Press **HP-IB TLK/LSN** and specify the HP-IB address of the printer. (Default is 1.)

You can select an HP-IB address through the numeric keypad or HP-HIL keyboard and press **ENTER**. (If you make an error, press **←** to return to the previous menu. Repeat your selection with the corrected entry if necessary.)

Printers in this procedure use an HP-IB address.

This procedure is for printers that are not configured as an MMS element and they do not have an MSIB address; without an MSIB address, these printers will not show up in the MSIB address map.

To set the printer address of an MMS printer

1. Press **DISPLAY** **Hard Copy printer address**.
2. Press **MSIB COLUMN** and specify the MSIB address of the printer. (Default is ROW 0 and COLUMN 1.)

You can select an MSIB address through the numeric keypad or HP-HIL keyboard and press **ENTER**. (If you make an error, press **←** to return to the previous menu. Repeat your selection with the corrected entry if necessary.)

Printers in this procedure use an MSIB address.

This procedure is for printers that operate as if they were an element on the MSIB; in order for them to do this, they must have an MSIB address assigned to them and they will therefore show up in the MSIB address map.

Printing and Plotting

To set the plotter configuration

1. Press **DISPLAY** **Hard Copy** **plotter config**.
2. Press **SINGLE PEN** or **SIX PENS**.

SINGLE PEN is used to select a single pen for the whole drawing.

SIX PENS is used to select that six different color pens be used for the drawing.

3. To set the desired dimensions of your output drawing, press one or more of the **X-min**, **Y-min**, **X-max**, **Y-max** keys and use the numeric keypad or HP-HIL keyboard and press **ENTER**. (If you make an error, press **←** to return to the previous menu. Repeat your selection with the corrected entry if necessary.)
4. Obtain the instrument display you want to plot by using the menu keys in the **MENU** or **USER** menus.
5. Once you have obtained the instrument display that you want to plot, press the **PLOT** key; the plotting process will begin immediately.

Plotting can be halted by pressing any front panel key on the display during the plot sequence. Once the plotting begins, the screen will be frozen until the data transfer to the plotter is complete.

To set the plotter address of a non-MMS plotter

1. Press **DISPLAY** **Hard Copy**.
2. Press **plotter address** and specify the HP-IB address of the plotter. (Default is 1.)

You can select an HP-IB address through the numeric keypad or HP-HIL keyboard and press **ENTER**. (If you make an error, press **←** to return to the previous menu. Repeat your selection with the corrected entry if necessary.)

Plotters in this procedure use an HP-IB address.

This procedure is for plotters that are not configured as an MMS element and they do not have an MSIB address; without an MSIB address, these plotters will not show up in the MSIB address map.

To set the plotter address of an MMS plotter

1. Press **DISPLAY** **Hard Copy plotter address**.
2. Press **MSIB COLUMN** and specify the MSIB address of the plotter. (Default is ROW 0 and COLUMN 1.)

You can select an MSIB address through the numeric keypad or HP-HIL keyboard and press **ENTER**. (If you make an error, press **←** to return to the previous menu. Repeat your selection with the corrected entry if necessary.)

Plotters in this procedure use an MSIB address.

This procedure is for plotters that operate as if they were an element on the MSIB; in order for them to do this, they must have an MSIB address assigned to them and they will therefore show up in the MSIB address map.

Selecting and Saving to External Mass Storage Devices

The previously described procedure, "To save a system configuration", does not save information permanently. If you would like to save your work to a permanent storage media device, there are two mass storage devices available:

- An external **HP-IB disk drive**
- An internal **memory card**

To save your work to a permanent storage media device	4-31
To select an HP-IB disk drive as a storage device	4-32
To select the memory card as a mass storage device	4-33
To install a memory card	4-34
To change the battery on a RAM memory card	4-35
To format a memory card	4-37

To save your work to a permanent storage media device

1. Set the msi [mass storage is] of the HP 70004A color display to either an HP-IB disk drive or a memory card with one of the following procedures in this section.
 - To select an HP-IB disk drive as a storage device
 - To select the memory card as a mass storage device
2. After setting an msi, establish a display link with one of the master modules in your system by pressing either **NEXT INST** (this causes ROW 0 to be scanned for master modules) or create a new window link using one of the following procedures:
 - To build 1, 2, or 4 windows on the display
 - To stack 2 or 4 windows on the display
 - To build custom sized windows on the display
3. After establishing a display link with a master module, press **USER** or **MENU** and use the appropriate softkeys.

Under **USER**, you may have softkeys for DLPs and under **MENU**, you may have softkeys that are specific to the module that you selected. For information on using softkeys, refer to the user guide for your specific module.

The information displayed, once the display is given to an instrument, depends on the specific instrument selected. Since **NEXT INSTR** only establishes communication links between the display and the instrument, most instrument settings are not affected when an instrument is selected; however, any previously defined display windows are erased.

Selecting and Saving to External Mass Storage Devices

To select an HP-IB disk drive as a storage device

1. Press **DISPLAY** **Mass Storage** **msi** **HP-IB disk**.

2. Press **HP-IB ADDRESS**.

Enter the HP-IB ADDRESS of the HP-IB disk. (Default is 0.)

3. Press **UNIT NUMBER**.

Enter the UNIT NUMBER of the HP-IB disk. (Default is 0 for a hard disk and 1 for a floppy disk.) For example, when using an HP 9133H disk drive, unit number 0 is the hard disk, and unit number 1 is the floppy disk.

4. Press **VOLUME NUMBER**.

Enter the VOLUME NUMBER of the HP-IB disk. (Default is 0.) Normally this is number 0 for a floppy disk. This function is only used if the disk drive is divided into several volumes.

In order to use this procedure, you must perform "Step 7 (Optional). Connecting an HP-IB Disk Drive" in Chapter 1.

Once the disk drive is connected to the display's HP-IB connector, data can be stored on an HP-IB disk by instrument modules using the display.

Once **msi** (mass storage is) is set, instruments may access the memory device (for example, an HP-IB disk drive) through the display without the need of an external controller for saving and recalling instrument states, user keys, limit lines, traces, and programs.

The data is stored in logical interchange format (LIF) files.

-
- CAUTION**
- To avoid corrupting the mass storage medium, do *not* press any display front panel keys while a mass storage operation is in progress.
 - Some instruments (for example, the spectrum analyzer) can access their own internal memory or external HP-IB disk drives. For more information refer to your instrument's operation manual.
-

To select the memory card as a mass storage device

1. Press **DISPLAY** **Mass Storage** **msi** **MEMORY CARD**

Data can be stored directly on the memory card by instrument modules without the use of an external disk drive.

Once **msi** (mass storage is) is set, instruments may access the memory device (for example, an HP-IB disk drive) through the display without the need of an external controller for saving and recalling instrument states, user keys, limit lines, traces, and programs.

The data is stored in logical interchange format (LIF) files.

-
- CAUTION**
- To avoid corrupting the mass storage medium, do *not* press any display front panel keys while a mass storage operation is in progress.
 - Some instruments (for example, the spectrum analyzer) can access their own internal memory or external HP-IB disk drives. For more information refer to your instrument's operation manual.
-

Selecting and Saving to External Mass Storage Devices

To install a memory card

CAUTION Improper card insertion can cause error messages to occur, but generally does not damage the card or instrument. Care must be taken, however, not to force the card into the card reader slot.

1. Locate the arrow printed on the card label.
2. Insert the card with the arrow on the card matching the arrow above the card-reader slot.
3. Press the card into the slot. When correctly inserted, approximately 19 mm (0.75 in) of the card is exposed.

Memory cards provide storage media and access routines and instrument personalities; these are called down-loadable programs (DLPs).

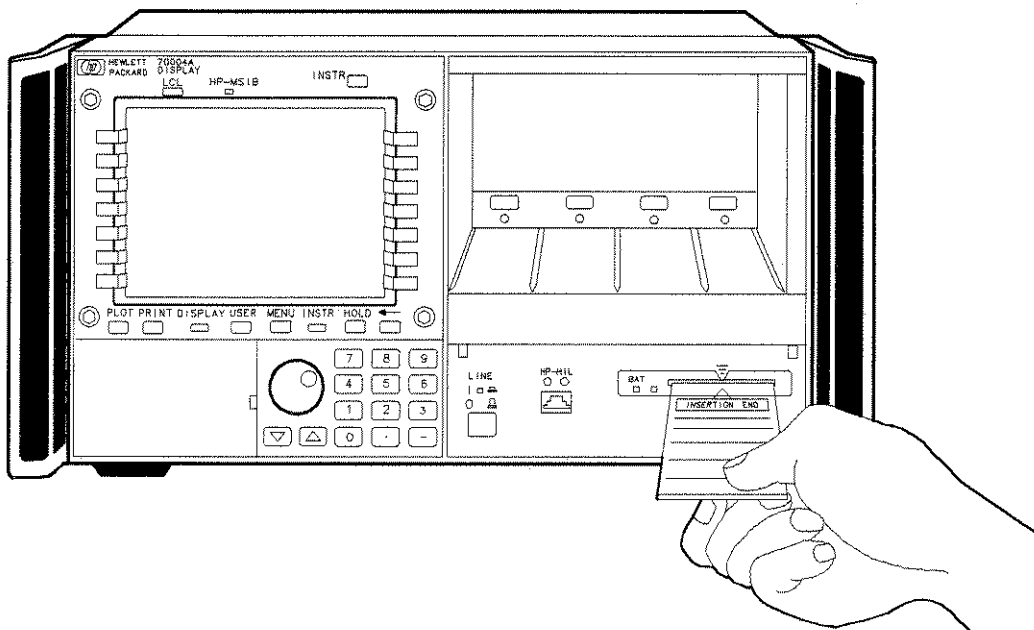

To change the battery on a RAM memory card

CAUTION RAM memory cards must be installed in an HP 70004A color display when the battery is removed (ROM memory cards do not have a battery). Be sure that the HP 70004A color display is powered on before removing the battery. If the battery is removed while the memory card is not installed in the HP 70004A color display, all data in the RAM memory card is lost. Store memory-card files on another device before changing the battery, when extra care is appropriate.

1. Install the RAM memory card into the HP 70004A color display's memory card reader slot.
2. Locate the groove of the battery clip at the front edge of the card.
3. Gently pry the battery clip out of the card. The battery fits within this clip. The red BAT LED on the display front panel should turn on.
4. Replace the battery, making sure the plus (+) sign on the battery is on the same side as the plus (+) sign on the clip.
5. Insert the battery clip into the RAM memory card, holding the clip as oriented in the following figure. (Face the open edge of the clip toward the write-protect switch on the RAM memory card.)
6. Write the date that the battery was replaced on the memory-card label to remind you when the battery should be replaced.

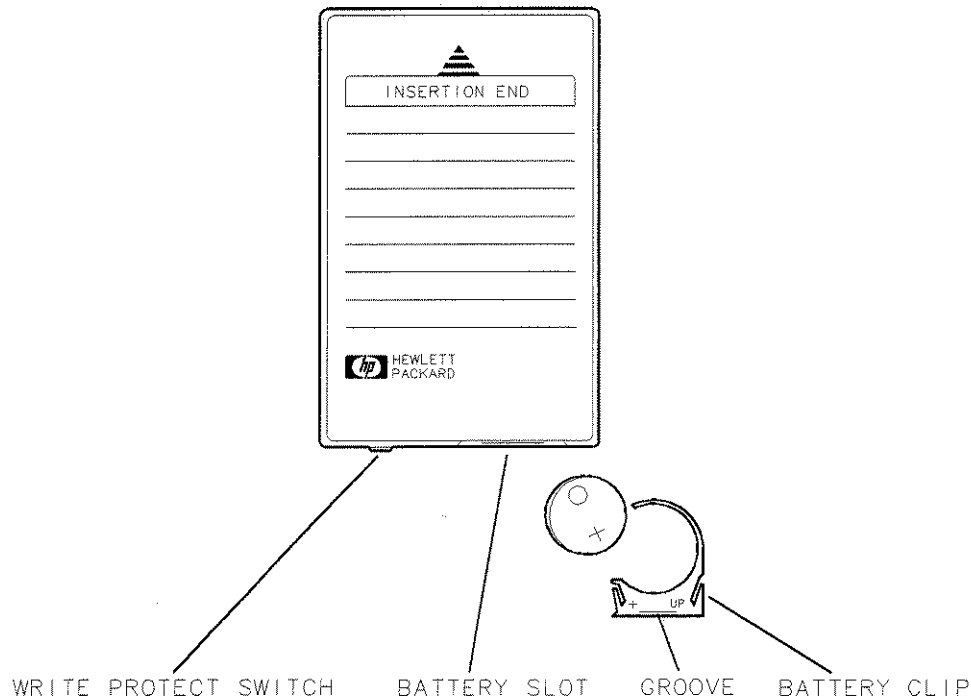

Figure 4-1. RAM Memory Card Battery Replacement

Selecting and Saving to External Mass Storage Devices

The battery is located beside the RAM memory card's write-protect switch on the opposite end of the connector.

The RAM memory card requires power. Items stored in the RAM memory card remain as long as the card has sufficient power (ROM memory cards do not require continuous power). The HP 70004A color display provides power to the memory card when it is installed and continues to supply power only when the HP 70004A color display is powered on. When the RAM memory card is removed or the display is powered off, power is supplied by a battery within the RAM memory card.

Change the RAM memory card battery every two years. On new cards, the time of installation is engraved on the side of the card. The first digit refers to the year. The next two characters refer to the month, and the last digit refers to the week. For example, 3OC3 indicates the battery was installed during the third week of October in 1993.

The date that the RAM memory card battery was installed is either engraved on the side of the RAM memory card or written on a label on the RAM memory card.

If the RAM memory card does not have a label with the date that the battery was installed, use the date code engraved on the side of the RAM memory card. The date code engraved on the RAM memory card consists of numbers and letters engraved in the black plastic on the side of the RAM memory card. The first number indicates the year, the following two characters indicate the month, and following number indicates the week in the month that the RAM memory card battery was installed. For example, 7JA2 indicates the battery was installed on the second week in January, 1997.

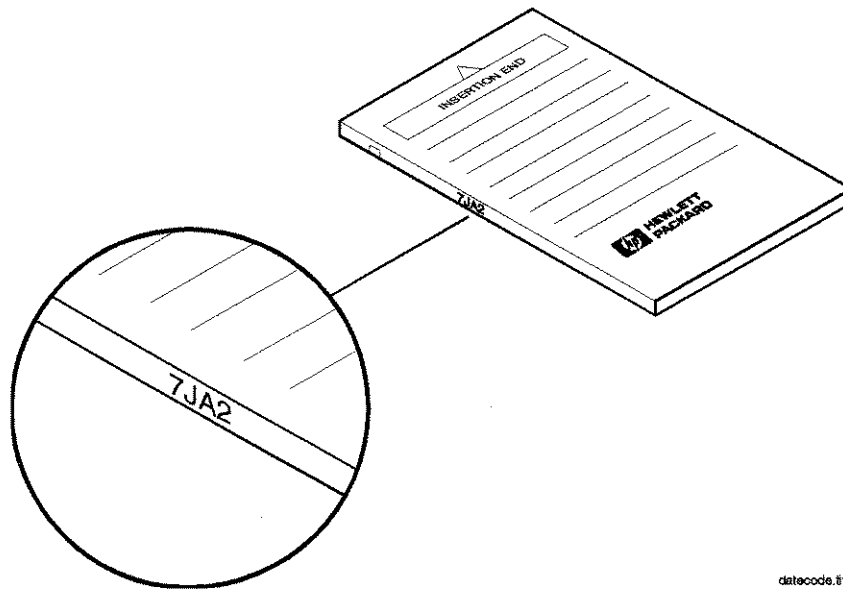

Figure 4-2. Memory Card Date Code Location

To format a memory card

CAUTION **FORMAT** erases the contents of the currently selected memory. Be sure to select the desired memory before executing **FORMAT**. Internal memory is selected automatically when power is applied.

1. Insert the memory card.
2. Press **DISPLAY** **Misc** **MORE** **MSIB CARD**.

If the card is in another MSIB device (other than the HP 70004A color display), press **Misc**, **MORE**, **MSIB CARD**, then enter its MSIB address (that is, the COLUMN address and ROW address \times 32).

3. Press **FORMAT**.

New memory cards need to be formatted before use. Use the **FORMAT** softkey to format new memory cards with the logical-interchange-file (LIF) format. **FORMAT** can also be used to format used memory cards, but note that the *formatting process destroys all stored data*.

Miscellaneous User Tasks

To erase volatile and non-volatile user RAM	4-38
To turn the HP logo ON or OFF	4-38
To examine errors reported by the display	4-38
To view current display information (firmware, address, model, etc.)	4-39

To erase volatile and non-volatile user RAM

1. Turn off the main power.
2. Remove the battery on the processor board to ensure the RAM discharges at power-down.

This step requires that the covers of the HP 70004A color display be removed and should only be done at an ESD workstation by qualified personal. For further information, refer to the *HP 70004A Service Guide*.

3. Cycle power on and then off again.

After using this product, the user RAM may contain potentially sensitive or classified information.

There is 64 KB of CMOS RAM that is backed up by a battery on the processor board. This RAM is used as a buffer for printer and plotter dumps.

To turn the HP logo ON or OFF

1. Press **DISPLAY** **Misc HP LOGO DISPLAY**.

HP LOGO DISPLAY switches on (indicated by the underlined key label) or off.

When on (default), the HP logo in the status information area appears on the display screen.

To examine errors reported by the display

1. Press **DISPLAY** **REPORT ERRORS**.

When the **REPORT ERRORS** softkey is pressed, the display will list the description of all of the errors. If more than one instrument has reported errors, a **MORE ERRORS** softkey will appear. When pressed, the screen will list the next instrument's errors. This is a one-time transfer of information; there is no updating. Listing the description of an error will clear the error if it is not hardware related.

Most errors reported on the MSIB system are transient errors such as those caused by illegal commands over HP-IB. These errors, once reported via **REPORT ERRORS**, are cleared from memory and they cannot be reported or viewed a second time.

To view current display information (firmware, address, model, etc.)

1. Press **DISPLAY** **Misc** **DISPLAY ID**.

DISPLAY ID displays the following information:

- Color Palette
(In 16 boxes centered on the top two rows. Colors 0–7 are on the top row, and 8–15 on the next row down.)
- Copyright notice
- HP model number
- Firmware version
- MSIB address
- HP-IB address
(Displays HP-IB Address: OFF if the rear panel HP-IB switch is off.)
- Custom key-panel ID code

Note The **DISPLAY ID** does not provide the ROM version of other instruments in the system. For that information, see the appropriate section of the operating instructions for your instrument. The display's MSIB address can only have a row address of zero. The factory-shipped default address is ROW 0, COLUMN 4 (0, 4).

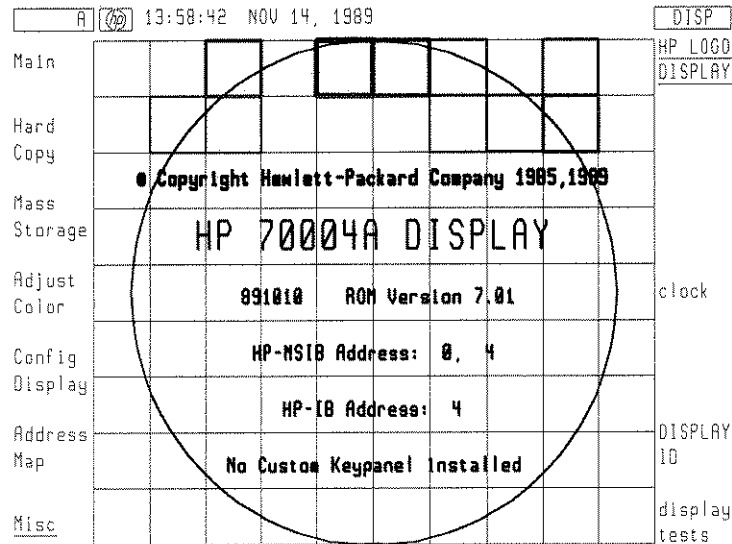

Display ID Screen

DISPLAY Softkey Reference

Summary In this chapter you will learn about:

- Softkeys available when **DISPLAY** is selected and what each softkey can do.
-

This chapter introduces the conventions used in the softkey menus. Then all of the softkeys available through the **DISPLAY** key are described. The softkeys are described according to their position on the display menus.

For information on how to use the softkeys for a specific instrument other than the display (softkeys that appear when selecting instruments with the **USER**, **MENU**, or **INSTR** keys), refer to the instrument's user documentation.

Main	5-3
Hard Copy	5-6
Mass Storage	5-12
Adjust Color	5-15
Config Display	5-21
Address Map	5-26
Misc	5-29

When you first start your HP 70004A color display, an initial set of top-level softkeys will appear. Depending on whether **DISPLAY**, **USER**, or **MENU** is selected, a different set of top-level softkeys are available; the softkey set is dependent on the instrument in control of the keyboard.

Selecting one of the top-level softkeys on the left side of the display allows access to a menu of softkeys on the right side of the display. Each softkey that is displayed on the right side either performs a function directly or accesses another menu of related softkeys.

Softkey Text that looks like this (with an initial uppercase letter followed by all lowercase letters) represents a top level softkey. All top level softkeys access a set of softkeys that are functionally related; these softkeys are generally found only on the left side of the display.

SOFTKEY Text that looks like this (with all uppercase letters) represents a softkey that executes its function. When a softkey is underlined, it is set to on; clicking on an underlined softkey toggles it between on and off.

softkey Text that looks like this (with all lowercase letters) represents a softkey that accesses another menu of related softkeys.

MORE Some of the softkey functions are too numerous to display all at once, and for this reason are divided into "pages". Press **MORE** to view additional pages.

prev menu Use the previous-menu key, **prev menu**, or backspace **←** key, to return to previously displayed level of keys.

Main

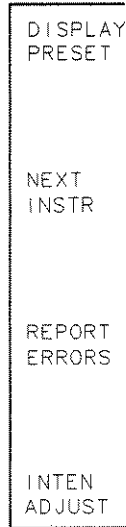

main

Figure 5-1. Main Keys

The **Main** softkey accesses the **DISPLAY PRESET**, **NEXT INSTR**, **REPORT ERRORS**, and **INTEN ADJUST** functions. The main menu is selected whenever the **DISPLAY** key is pressed.

DISPLAY PRESET

Key Path: **DISPLAY DISPLAY PRESET**

- Actions:
- Produces one window and assigns it to the last instrument to own the keyboard.
 - Clears the screen.
 - Resets the display to one window.
 - Assigns the entire screen to the last module assigned the keyboard (if any).
 - Resets the HP-IB interface (clears the input and output buffers, plus the SRQ).
 - Resets the mass storage system.
 - Note that **INSTR PRESET** does not preset the display since the display is a separate instrument (from a spectrum analyzer for example). Therefore, if four windows are configured and **INSTR PRESET** is pressed, the four windows will remain, whereas **DISPLAY PRESET** will reset the screen back to one window but *not* reset the instrument that owns the keyboard.

NEXT INSTR

Key Path: DISPLAY NEXT INSTR

- Actions:
- Establishes initial contact between the display and a single instrument.
 - Steps to the next instrument on row 0 of the address map.
 - Pressing Δ or ∇ causes a search up or down through the address map for the next instrument.
 - Establishes a link between the display and one instrument at a time.
 - For example, if one instrument is being displayed on a single window and you want to display another instrument on that same window, NEXT INSTR may be used to step to the next window.
 - Causes the display to show measurement results and control operation of the next instrument on row 0 of the address map. If none is found higher than the current one, the display will start at column zero and work its way up to the next address containing an instrument. For more information about addressing and the address map, refer to "DISPLAY Address Map".
 - At power-on, the display prompts the user to press NEXT INSTR. If during a previous session, NEXT INSTR had been pressed and the screen is assigned to an instrument, the display will automatically attempt to re-establish a link to that instrument. In that case, as soon as the link is established, the power-up prompt will go away. In most cases, this will happen so soon after the link is offered that the prompt will flash on the screen and be gone.
 - If you press MENU or USER the menu-key labels disappear. No key, other than DISPLAY, PRINT, or PLOT will give a response.
 - MENU and USER do not call up any keys because an instrument is not currently linked to the display. All keys under USER and MENU are created by and responded to by an instrument (such as the spectrum analyzer), while all keys under DISPLAY are generated by the display itself.

REPORT ERRORSKey Path: **DISPLAY** **REPORT ERRORS**

- Actions:
- When an instrument or module has an error, it informs every instrument that resides on row 0 of the address map. This will cause an E (the E is red on the HP 70004A color display) to appear in the status box of every display. When the **REPORT ERRORS** softkey is pressed, the display will list the description of all of the errors. If more than one instrument has reported errors, a **MORE ERRORS** softkey will appear. When pressed, the screen will list the next instrument's errors. This is a one-time transfer of information; there is no updating. Listing the description of an error will clear the error if it is not hardware related.
 - Most errors reported on the MSIB system are transient errors such as those caused by illegal commands over HP-IB. These errors, once reported via **REPORT ERRORS**, are cleared from memory and they cannot be reported or viewed a second time.
 - Other errors reported can be hardware errors. These are caused by hardware problems such as unconnected back panel cables (see the following example) or the failure of an internal component. These problems can affect operation of the instrument, and cannot be cleared from memory until corrected.

Note Some transient errors can be cleared by pressing either **USER** or **MENU**, or by pressing the **DISPLAY** and **REPORT ERRORS** keys.

INTEN ADJUSTKey Path: **DISPLAY** **INTEN ADJUST**

- Actions:
- Resets the default intensity to 9.
 - The **INTEN ADJUST** (intensity adjustment) softkey changes the display screen's video amplitude (brightness). Intensity is incrementally adjustable (using the knob, step keys, or keypad) from 0 to 19 in steps of 1. The default intensity is set at 9.

Note

- The 0 intensity setting may not be completely off.
- If red fringes appear to the right of some colors, the selected intensity is set too high for the current brightness setting. Lower the intensity of the brightness setting.

Hard Copy

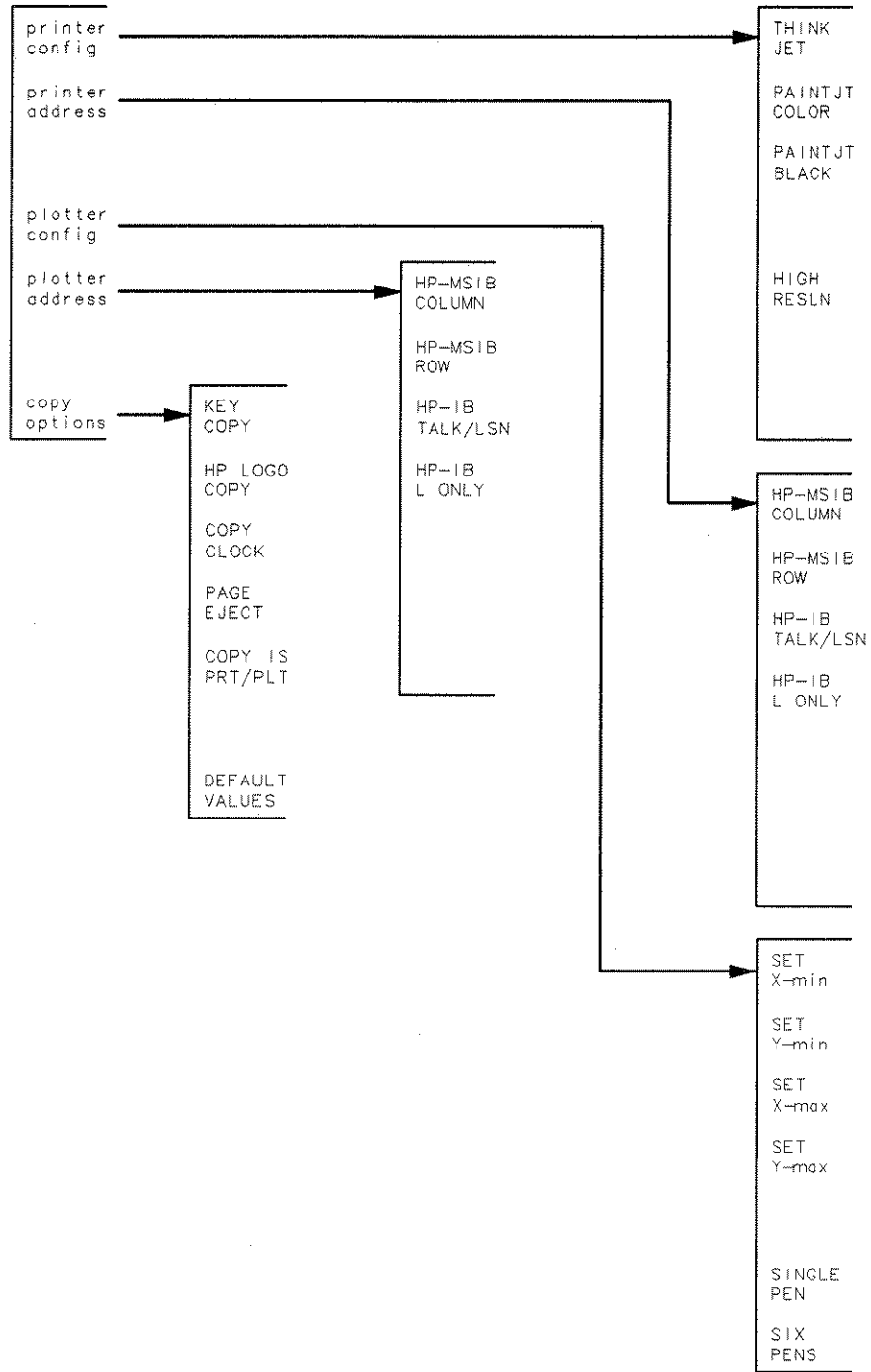

hardcopy1

Figure 5-2. Hard Copy Keys

The **Hard Copy** softkey accesses printing and plotting functions. Also covered are the definitions (addresses, plot sizes, and so on) that are used for printing and plotting.

printer config

Key Path: **DISPLAY** Hard Copy printer config

Actions: **printer config** determines the type of printer output.

PAINTJT COLOR is the default printer mode. If you are using an HP ThinkJet printer, activate the **THINK JET** softkey.

Table 5-1. HP PaintJet Color Map

Color Number ¹	PaintJet Low Resolution			Color Name	PaintJet High Resolution			Color Name
	Red	Green	Blue		Red	Green	Blue	
0	90	88	85	white (no ink)	90	88	85	white (no ink)
1	43	43	45	light gray	4	4	6	black
2	73	41	16	orange/yellow	3	26	22	green
3	2	22	64	cyan	2	22	64	cyan
4	53	5	25	magenta	53	5	25	magenta
5	10	38	22	green	3	26	22	green
6	4	4	6	black	4	4	6	black
7	11	14	18	medium gray	4	4	6	black
8	63	20	15	amber	53	8	14	red
9	53	8	14	red	53	8	14	red
10	4	4	6	black	4	4	6	black
11	4	4	6	black	4	4	6	black
12	11	14	18	medium gray	4	4	6	black
13	53	8	14	red	53	8	14	red
14	10	38	22	green	3	26	22	green
15	4	4	29	blue	4	4	29	blue

¹ The color number refers to the same color number as in the **Adjust Color** edit colors menu.

printer address

Key Path: DISPLAY Hard Copy printer address

- Actions:
- **printer address** defines the HP-IB address of the output printer.
 - Use the **MSIB COLUMN** and **MSIB ROW** softkeys if an MSIB print device is configured into the system.
 - Switching the **HP-IB TLK/LSN** (talk/listen) key on means the display expects the printer to be in talk/listen mode on HP-IB. When the **HP-IB TLK/LSN** mode is switched on, the address may be changed using the knob or numeric-entry keys. The default HP-IB printer address is 1.
 - Switching the **HP-IB L ONLY** (listen only or listen always) key on means the display expects the printer to be in the listen-only mode on HP-IB. No attempt will be made to address the printer.

plotter config

Key Path: DISPLAY Hard Copy plotter config

- Actions:
- The **plotter config** softkey defines the limits used for plotter outputs when the display cannot ask the plotter what limits to use (for example, listen-only plotters).
 - It also determines how many plotter pens the display will try to use.
 - The **SET X-min**, **SET Y-min**, **SET X-max**, and **SET Y-max** keys set the P1 and P2 corner points for the plotter.
 - Switching the **SINGLE PEN** softkey on tells the display to plot using only plotter PEN 1. This function is useful if photocopying the plots, for one pen plotters, or for faster plotting.
 - Switching the **SIX PENS** softkey on tells the display to plot using 6 plotter pens. The internal pen numbers (1–15) are mapped to six pens (1–6) as shown in Table 5-2.
 - **plotter config** alters the physical size of hardcopy output plots. On HP Plotters, the physical size and shape of output plots are determined by the locations of the *Scaling Points*, P1 and P2. These locations are given in Cartesian coordinates; for example, P1 = 100, 100 and P2 = 10100, 7600. The actual size of these units depends on the specific plotter used. Typical unit size is 0.025 mm, or about 0.001 inch. The units are referenced from the lower-left corner of the available plotting surface.
 - The default plotting area for the HP 7475A 6-Pen graphics plotter is outlined. P1 is the lower-left corner, P2 is the upper-right corner.
 - The plotter parameters are stored in a continuous-memory register; they will be retained even after the power has been turned off. Turning the system off and then on (or pressing the **DISPLAY PRESET** softkey) will not reset the plotter parameters to their default values. The display uses these stored values if it cannot interrogate the plotter; otherwise it simply gets them from the plotter. The display cannot interrogate the plotter if the plotter is a listen-only device. The display also cannot interrogate a talk/listen plotter if the output is initiated by remote control, over HP-IB, or from a module using the display's CY 1 command.

Table 5-2. Mapping of Display Pens to Plotter Pens

On Screen Pen	Default Colors	Plotter Pen	Recommended Pen Color	Spectrum Analyzer
1	Dim Gray	4	Blue	Graticule
2	Yellow	1	Black	Trace A
3	Cyan	6	Brown	Trace B
4	Pink	5	Violet	Trace C
5	Green	3	Green	Limit Lines
6	White	1	Black	Active Parameter
7	Half Bright	3	Green	Annotation
8	Amber	2	Red	Advisory Messages
9	Red	2	Red	Errors
10	White	1	Black	Markers
11	Bright Gray	1	Black	Key Labels
12	Half Bright	1	Black	System Status
13	Red	2	Red	
14	Green	3	Green	
15	Blue	4	Blue	

p2

Default Plotter Parameters

(as set by the display)

X-min = 100

Y-min = 100

X-max = 10,100

Y-max = 7,600

p1

Plotter Parameters as Set by the HP 70004A Color Display

plotter address

Key Path: DISPLAY Hard Copy plotter address

- Actions:
- **plotter address** defines the HP-IB address of the hardcopy output plotter.
 - Use the **MSIB COLUMN** and **MSIB ROW** softkeys if an MSIB plot device is configured into the system.
 - Switching the **HP-IB TLK/LSN** key on means the display expects the plotter to be in the talk/listen mode on HP-IB. When the **HP-IB TLK/LSN** mode is switched on, the address may be changed using the knob or numeric-entry keys. The default HP-IB plotter address is 5.
 - Switching the **HP-IB L ONLY** (listen only or listen always) key on means the display expects the plotter to be in listen-only mode on HP-IB. Note that a listen-only plotter cannot tell the display where its corner points (P1, P2) are located. With a listen-only plotter the display will always use the P1 and P2 corner points stored under the **plotter config** softkey, since it cannot determine the plotter's actual P1, P2 configuration.

copy options

Key Path: DISPLAY Hard Copy copy options

- Actions:
- **copy options** offers the user a variety of plot and print options, which are described below.
 - Switching the **KEY COPY** softkey on prints or plots the key labels, system annunciator block, and the menu annunciator block during hardcopy outputs. The default state is off.
 - Switching the **HP LOGO COPY** softkey on print or plots the HP logo in the status window during hardcopy outputs, independent of the state of the **HP LOGO DISPLAY** softkey in the **Misc** menu.

If the **HP LOGO COPY** softkey is off and the **HP LOGO DISPLAY** softkey is on, the HP logo is still output. **HP LOGO COPY** only overrides if the **HP LOGO DISPLAY** is off.

- Switching the **CLOCK COPY** softkey on prints or plots the real-time clock readout in the status window during hardcopy outputs, independent of the state of the **CLOCK DISPLAY** softkey in the **Misc** menu.

If the **CLOCK COPY** softkey is off and the **CLOCK DISPLAY** softkey is on, the clock is still output. **CLOCK COPY** only overrides if **CLOCK DISPLAY** is off.

- Switching the **PAGE EJECT** softkey on, form feeds the printer at the end of the printer output and ejects a page at the end of plotter outputs.

Many plotters do not implement a page eject feature. Some of these plotters report an error on PAGE EJECT so leave it off if using such a plotter.

- The **COPY IS PRT/PLT** softkey determines whether the printer or plotter will be the destination when the copy (CY) display command is sent via HP-IB or MSIB during remote controlled applications. For example, when the PLOT command is sent to the HP 70900B local oscillator source over HP-IB,

the HP 70900B local oscillator source sends a CY command to the display over MSIB.

- The **DEFAULT VALUES** softkey sets each of the other functions in this menu to the following default settings:

Table 5-3. Default Values of copy options

PRINTER IS:	HP-IB Talk/Listen at address 1.
PLOTTER IS:	HP-IB Talk/Listen at address 5.
KEYCOPY:	OFF
HP LOGO COPY:	ON
CLOCK COPY:	ON
PAGE EJECT:	ON
COPY IS:	PRINTER
PLOTTER PARAMS:	Plot limits of X-min, Y-min = 100, 100
	Plot limits of X-max, Y-max = 10100, 7600

Note

- The default plotter limits are those of the HP 7470A and the HP 7475A plotters. These allow 0.5 inch margins on standard A-size paper (8.5 by 11 inches).
 - Printer and plotter outputs can't be produced if an HP-IB controller (computer) is connected to the same HP-IB connector as the output device.
 - Printer or plotter outputs initiated remotely (for example, using the PLOT command in the Spectrum Analyzer) depend on the setting of the SYSTEM CONTROLLER switch on the rear of the display. If the switch is on (up), the display will address the printer or plotter and handle their output. If the switch is off (down), the display will output the data only when addressed to talk by the system controller (computer).
 - The display buffers plotter output data for one plot. Thus when **PLOT** is pressed, the screen freezes for a moment (longer, if there is too much plot data to fit in the buffer), then resumes displaying data while simultaneously plotting. Pressing **PLOT** again while the data is being output terminates the plot, it does *not* start another one.
-

DISPLAY Mass Storage

Mass
Storage

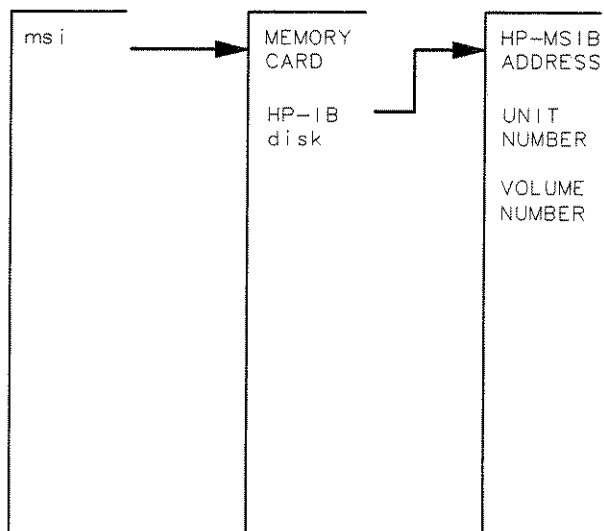

massto

Figure 5-3. Mass Storage Keys

The **Mass Storage** softkey accesses two separate memory devices for saving and recalling instrument states, data, traces, user keys, limit lines, and programs (DLPs).

The devices are:

- An internal **Memory Card**
- An external **HP-IB disk drive**

msi

Key Path: **DISPLAY** **Mass Storage** **msi**

- Actions:
- **msi** sets the HP 70004A color display's current mass memory device.

Once **msi** (mass storage is) is set, instruments may access the memory device (for example, an HP-IB disk drive) through the display without the need of an external controller for saving and recalling instrument states, user keys, limit lines, traces, and programs.

The data is stored in logical interchange format (LIF) files. The example in Figure 5-4 and Figure 5-5 shows an instrument module (for example, an HP 70900B local oscillator source) at a remote antenna site using an HP-IB disk attached to the HP 70004A color display.

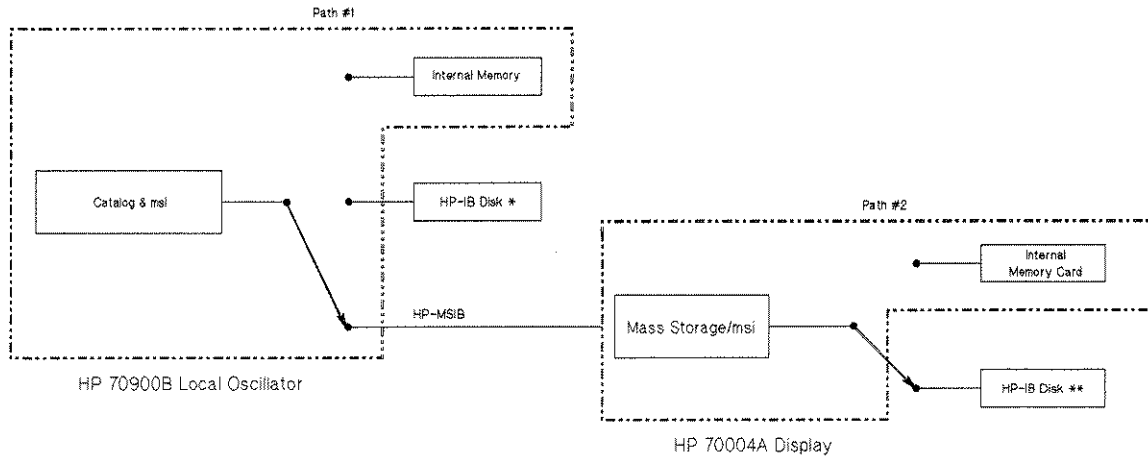

* HP-IB connector on the mainframe that contains the instrument module (can be the mainframe portion of the HP 70004A Display).

** The HP 70004A Display's HP-IB interface

Figure 5-4.

Example of an HP 70900B Local Oscillator Source Accessing an HP-IB Disk Drive

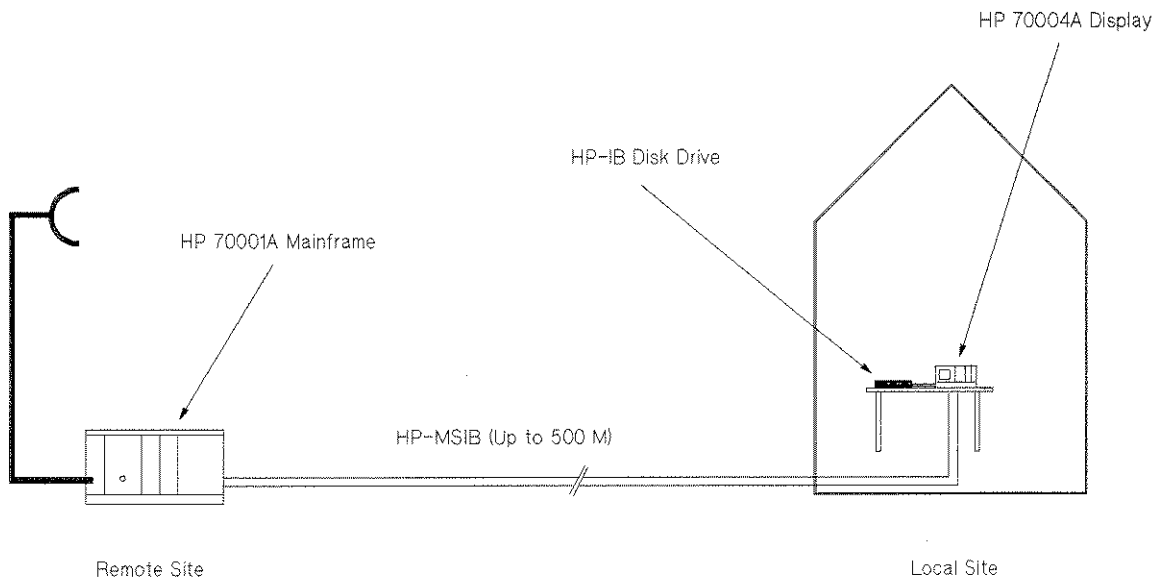

Figure 5-5. Using MSIB to Connect the Display to a Remote Antenna Site

MEMORY CARD

Key Path: **DISPLAY** Mass Storage msi **MEMORY CARD**

Actions: **MEMORY CARD** sets the memory card as the mass storage device.

Data can be stored directly on the memory card by instrument modules without the use of an external disk drive.

DISPLAY Mass Storage

HP-IB disk

Key Path: **DISPLAY** Mass Storage msi HP-IB disk

- Actions:
- **HP-IB disk** sets the mass storage device to the external HP-IB disk drive.
Data can be stored on the disk by instrument modules using the display. Once the disk drive is connected to the display's HP-IB connector, you need a way of specifying which disk is to be accessed.

Three parameters need to be entered:

- HP-IB ADDRESS**
- UNIT NUMBER**
- VOLUME NUMBER**

HP-IB ADDRESS

Key Path: **DISPLAY** Mass Storage msi HP-IB disk HP-IB ADDRESS

- Actions:
- **HP-IB ADDRESS** specifies the HP-IB address of the disk drive.

UNIT NUMBER

Key Path: **DISPLAY** Mass Storage msi HP-IB disk UNIT NUMBER

- Actions:
- **UNIT NUMBER** specifies which disk-drive unit to access.
For example, for an HP 9133H disk drive, unit number 0 is the hard disk, and unit number 1 is the floppy disk.

VOLUME NUMBER

Key Path: **DISPLAY** Mass Storage msi HP-IB disk VOLUME NUMBER

- Actions:
- **VOLUME NUMBER** specifies which disk drive volume to access.
Normally this is number 0 for a floppy disk. This function is only used if the disk drive is divided into several volumes.

DISPLAY Adjust Color

Adjust Color

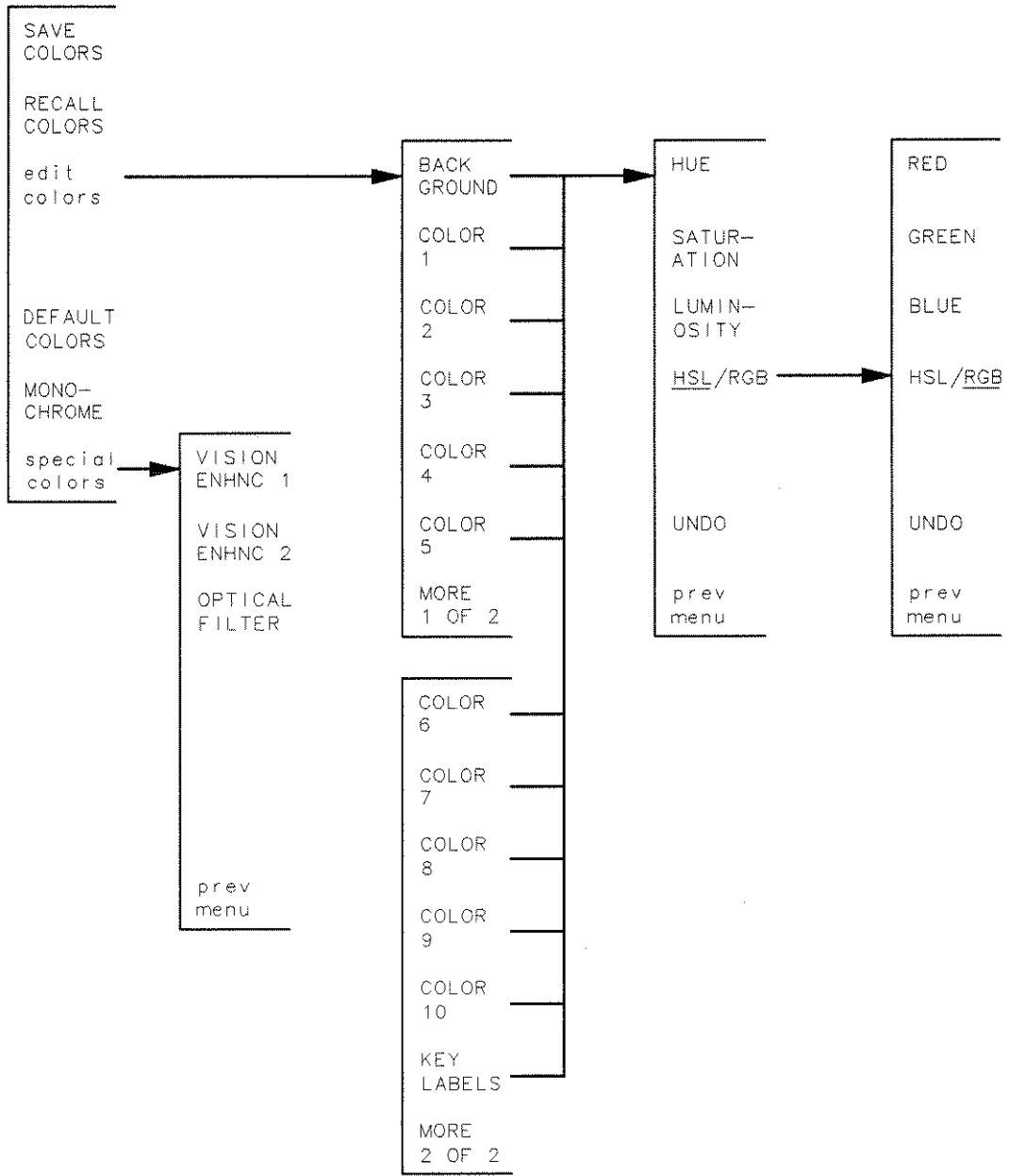

adjcolor

Figure 5-6. Adjust Color Keys

DISPLAY Adjust Color

Display colors have been preset with a set of default colors which you may choose to change in order to suit environmental needs, individual preferences, or to accommodate color-deficient vision.

The display's default colors have been chosen to maximize your ability to comfortably discern the difference between on-screen colors. We recommend these colors for normal use. They provide a suitable contrast that is easy to view for long periods of time.

The HP 70004A color display can display text and graphics in up to 16 simultaneous colors, selectable from a palette of 4096 colors.

SAVE COLORS

Key Path: **DISPLAY** Adjust Color **SAVE COLORS** 1-4 **ENTER**

Actions:

- **SAVE COLORS** saves the on-screen display colors in one of four color-save registers.

Note In ROM Version 7.0 the **Save Colors** function uses *volatile* memory. Colors saved will be lost when the power is turned off.

In ROM Version 7.01 and greater the **Save Colors** function uses *non-volatile* memory and colors saved will be retained when the power is turned off.

RECALL COLORS

Key Path: **DISPLAY** Adjust Color **RECALL COLORS** 1-4 **ENTER**

Actions:

- **RECALL COLORS** recalls the display colors saved with **SAVE COLORS**.
- Sometimes an instrument module will modify the colors on the screen to enhance a measurement. An example of this can be seen in the HP 70900B local oscillator source's **Persist On/Off** menu. When the screen is in this state, and the user enters the **Edit Colors** menu, the screen will return to the user's color palette, canceling the module's colors. If you wish to edit one of these module-modified color palettes you must first **SAVE** it, then **RECALL** it. This enters it into the user's palette and then it may be edited.

edit colors

Key Path: **DISPLAY** Adjust Color **edit colors**

Actions:

- **edit colors** changes the display screen colors.
- The **BACKGROUND** and **KEY LABELS** softkeys always appear in the **edit colors** menu, the instrument that owns the display's keyboard may generate all other key labels. In those cases when an instrument does not generate key labels, **COLOR 1** through **COLOR 10** will appear on the menu. Each key in the **edit colors** menu reflects the element color assigned that key. Keys whose associated colors are very dim appear surrounded by an inverse video block.
HSL (Hue, Saturation, and Luminosity) The HSL menu allows the user to turn the knob to change the three parameters

RGB

that represent hue (the pure color), saturation (the ratio of the pure color mixed with white), and luminosity (the brightness-per-unit area).

(Red, Green, Blue) The RGB menu allows the user to turn the knob to change the output of the three primary light sources (one each of red, green, and blue) that make up any color. The parameters specify the intensity of each of the light sources.

Table 5-4. Default Color Values for the Edit Colors Menu

Color	Default Colors	RGB			HSL			Spectrum Analyzers
		Red	Green	Blue	Hue	Saturation	Luminosity	Key Labels
0	Background	1	0	2	75	100	13	Background
1	Dim Gray	4	4	4	0	0	27	Graticule
2	Yellow	13	11	2	13	80	100	Trace A
3	Cyan	0	11	13	52	100	100	Trace B
4	Pink	13	4	7	93	73	000	Trace C
5	Green	0	13	0	33	100	100	Limit Lines, Trace D
6	White	15	15	15	0	0	100	Active Parameter
7	Half Bright	8	8	8	0	0	53	Annotation
8	Amber	15	8	0	9	100	100	Advisory Messages
9	Red	15	0	0	0	100	100	Errors
10	White	15	15	15	0	0	100	Markers
11	Bright Gray	12	12	12	0	0	80	Key Labels

Note A saturation of 0 (zero) means white, or no color. White can also appear as gray at low luminosities. Hue is meaningless for a saturation of 0, hence it cannot be adjusted when there is no color.

DEFAULT COLORS

Key Path: **DISPLAY Adjust Color DEFAULT COLORS**

Actions: ■ Sets all the display screen attributes to the factory-defined colors.

For a listing of the default colors, refer to Table 5-4.

MONOCHROME

Key Path: DISPLAY Adjust Color MONOCHROME

Actions: ■ MONOCHROME sets the display screen to green monochrome.

Table 5-5. Default Values for the Monochrome Display

Color	Default Colors	Green Value	Spectrum Analyzer
1	Dim Gray	4	Graticule
2	Yellow	10	Trace A
3	Cyan	7	Trace B
4	Pink	5	Trace C
5	Green	12	Limit Lines, Trace D
6	White	15	Active Parm
7	Half Bright	7	Annotation
8	Amber	12	Advisory Messages
9	Red	15	Errors
10	White	15	Markers
11	Bright Gray	12	Key Labels

special colors

Key Path: DISPLAY Adjust Color special colors VISION ENHNC 1 or,

DISPLAY Adjust Color special colors VISION ENHNC 2 or,

DISPLAY Adjust Color special colors OPTICAL FILTER

Actions: ■ The special colors built into vision-enhanced displays 1 and 2 accommodate most color-deficient vision problems. The optical filter was designed to accommodate the use of protective goggles while viewing lasers.

Table 5-6. Red, Green, and Blue Values for Vision Enhnc 1

		RGB			Spectrum Analyzers
Color	Default Colors	Red	Green	Blue	Key Labels
0	Background	1	0	2	Background
1	Dim Gray	4	5	0	Graticule
2	Yellow	8	6	12	Trace A
3	Cyan	0	11	13	Trace B
4	Pink	13	4	7	Trace C
5	Green	0	13	0	Limit Lines, Trace D
6	White	15	15	15	Active Parm
7	Half Bright	8	8	8	Annotation
8	Amber	15	8	0	Advisory Messages
9	Red	15	0	0	Errors
10	White	15	15	15	Markers
11	Bright Gray	12	12	12	Key Labels

Table 5-7. Red, Green, and Blue Values for Vision Enhnc 2

		RGB			Spectrum Analyzers
Color	Default Colors	Red	Green	Blue	Key Labels
0	Background	1	0	2	Background
1	Dim Gray	6	3	4	Graticule
2	Yellow	8	6	12	Trace A
3	Cyan	4	4	13	Trace B
4	Pink	7	4	13	Trace C
5	Green	0	13	0	Limit Lines, Trace D
6	White	15	15	15	Active Parm
7	Half Bright	8	8	8	Annotation
8	Amber	15	8	0	Advisory Messages
9	Red	15	0	0	Errors
10	White	15	15	15	Markers
11	Bright Gray	12	12	12	Key Labels

Table 5-8. Red, Green, and Blue Values for the Optical Filter

		RGB			Spectrum Analyzers
Color	Default Colors	Red	Green	Blue	Key Labels
0	Background	0	1	2	Background
1	Dim Gray	0	4	5	Graticule
2	Yellow	0	6	7	Trace A
3	Cyan	0	11	13	Trace B
4	Pink	0	4	13	Trace C
5	Green	0	13	0	Limit Lines, Trace D
6	White	15	15	15	Active Parm
7	Half Bright	0	8	8	Annotation
8	Amber	0	8	0	Advisory Messages
9	Red	15	15	15	Errors
10	White	15	15	15	Markers
11	Bright Gray	12	12	12	Key Labels

DISPLAY Config Display

Config Display

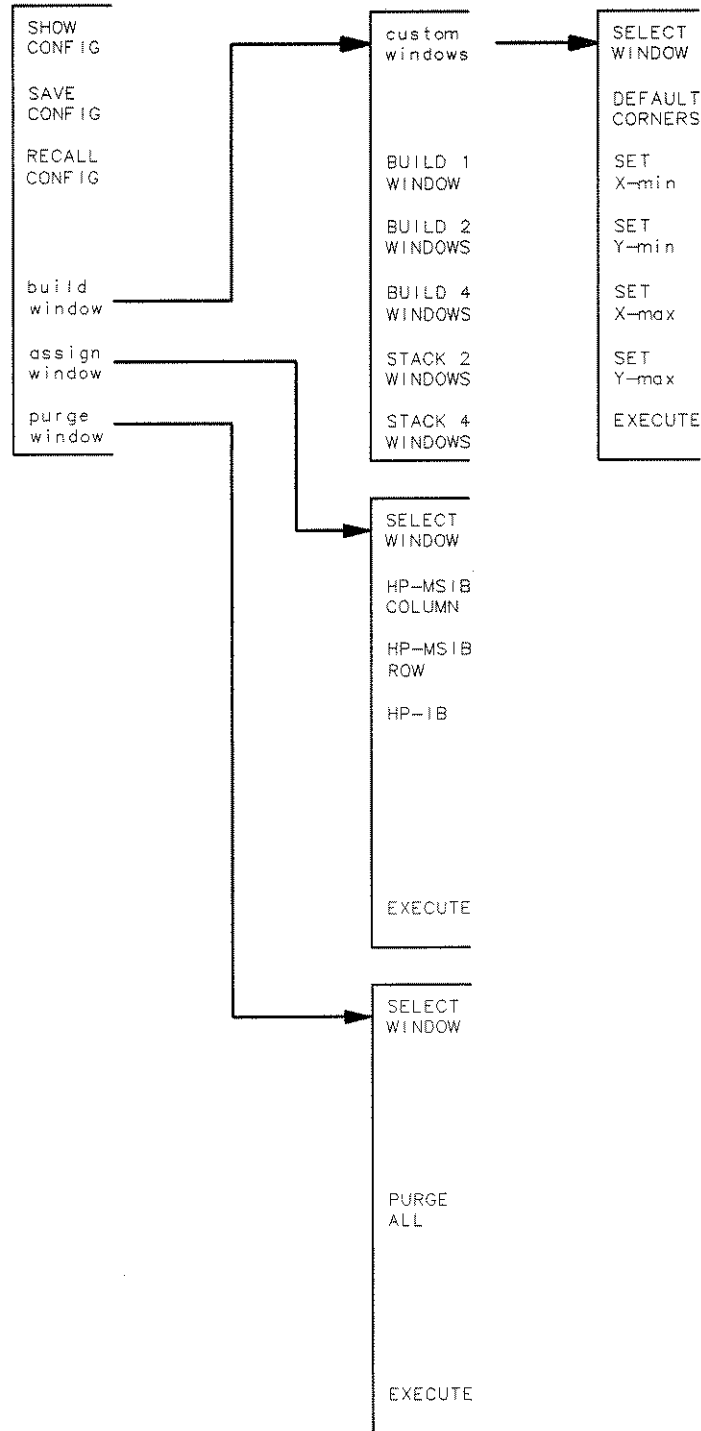

confdisp

Figure 5-7. Config Display Keys

DISPLAY Config Display

Config Display allows flexible display formatting of the HP 70000 Series modular measurement system. Up to four windows can be configured to display the traces, annotation, graticule, and measurement results of four different instruments on a single display.

SHOW CONFIG

Key Path: **DISPLAY** Config Display **SHOW CONFIG**

Actions:

- The **SHOW CONFIG** softkey displays a summary of current and stored display screen configurations. Use the **△** and **▽** keys to view all configurations.

SAVE CONFIG

RECALL CONFIG

Key Path: **DISPLAY** Config Display **SAVE CONFIG** or **RECALL CONFIG**

Actions:

- **SAVE CONFIG** saves the current screen in one of four configuration registers (with up to four windows per configuration).
- **RECALL CONFIG** recalls the windows to the display as they originally appeared when the windows were saved.

Note The current configuration will be retained in battery-backed RAM if the power is turned off.

build window

Key Path: **DISPLAY** Config Display **build window**

Actions:

- **build window** allows measurement displays in up to four predefined windows.

custom windows

Key Path: **DISPLAY** Config Display **build window** **custom windows**

Actions:

- The **custom window** softkey allows you to define your own windows with dimensions specified by the **X-min**, **Y-min**, **X-max**, and **Y-max** keys.
- The window being defined has a green border, the old window has a gray border, and the default window (selected by **DEFAULT CORNERS**) has a red border.
- The **SELECT WINDOW** softkey activates the window you wish to apply the **SET X-min**, **SET Y-min**, **SET X-max**, and **SET Y-max** keys to.
- The **DEFAULT CORNERS** softkey sets the window to the following dimensions: X-min = 112, Y-min = 16, X-max = 911, and Y-max = 383.
- The **EXECUTE** softkey finishes the building of a custom window by entering the new window into the current configuration.
- The **custom windows** submenu appears with **SELECT WINDOW** automatically underlined. The underline indicates that this function is active. Select a

window, numbered 1 through 4, by using any data entry method (step-keys, display knob, numeric keypad, or softkey). If the keypad is used to enter the window number, the user must press **ENTRY** to finish the entry.

13:57:19 NOV 14, 1989	DISP
Main	SELECT WINDOW
Hard Copy	DEFAULT CORNERS
Mass Storage	SET X-min
Adjust Color	SET Y-min
Config Display	SET X-max
Address Map	SET Y-max
Misc	EXECUTE
BUILD WINDOW 1	

Softkeys Available Under custom windows

The values of X-min, Y-min, X-max, Y-max represent the distances of the lines from the origin. The origin (X = 0, Y = 0) is located at the lower-left corner of the screen. The top-right corner of the screen is X = 1023, Y = 399. These dimensions are in display units (units of dots on the screen).

The standard-size window, available via **DEFAULT WINDOW**, has the following dimensions:

- X-min = 112
- Y-min = 16
- X-max = 911
- Y-max = 383

The default window is the window which is created by **SELECT INSTR**, **ASSIGN DISPLAY**, **DISPLAY PRESET**, and **BUILD 1 WINDOW**.

- Any window can be changed in size or shape by re-building. Up to four windows may be defined and written to simultaneously by different instruments; thus, four different instruments can *talk* to the display simultaneously. The screen annotation (usually present with one or two large windows) may not appear on smaller windows.
- The **BUILD 1 WINDOW**, **BUILD 2 WINDOWS**, **BUILD 4 WINDOWS**, **STACK 2**, and **STACK 4** softkeys can be used to construct multiple windows with a single keystroke.
- The **DISPLAY PRESET** or **NEXT INSTR** keys will return the display to a single full-screen window.

BUILD (#) WINDOW(S)

Build 1, 2, or 4 Windows

Key Path: **DISPLAY** Config Display build window **BUILD (#) WINDOW(S)**

- Actions:
- **BUILD (#) WINDOW(S)** display one, two, or four predefined windows and assigns instruments to them.
 - Any instruments already assigned windows will stay in those windows, if those windows remain on screen.

STACK (#) WINDOW(S)

Stack 2 or 4 Windows

Key Path: **DISPLAY** Config Display build window **STACK (#) WINDOW(S)**

- Actions:
- **STACK (#) WINDOW(S)** softkeys display two or four predefined horizontal windows and assign instruments to them.
 - Any instruments already assigned windows will stay in those windows, if those windows remain on screen.

Note In both *build* and *stack* functions, if windows remain unfilled, the display will search the address map for other instruments on row 0 to fill the windows. The windows are filled in order (1-4) and the modules are assigned in order of address (0-30). There is an exception to this rule. If a window has been assigned to a module and that module has been removed from the system, no attempt will be made to find another module for that window unless that window has first been purged using **purge window** or **PURGE ALL**.

assign windowKey Path: **DISPLAY** Config Display assign window

- Actions:
- **assign window** selects the instrument that will be assigned to a chosen window.
 - **SELECT WINDOW** activates the window you wish to assign an instrument to.
 - Select a module on MSIB by using **MSIB ROW**, **MSIB COLUMN**, and **EXECUTE**.
 - Access a window over HP-IB by using **HP-IB** and **EXECUTE**.
 - Any instrument on ROW 0 of the address map (or an HP-IB controller) can be assigned or re-assigned a window on the screen.
 - A window on the screen can be written to by any MSIB master module (for example, the HP 70900B local oscillator source) or by an HP-IB controller. **assign window** lets the user select the instrument that will write to a chosen window. The user can select a module on MSIB by using **MSIB ROW**, **MSIB COLUMN**, and **EXECUTE**.

Note

Use the **INSTR** key as the primary way of transferring the keyboard between instruments once they are assigned to windows. When the **INSTR** key is pressed, the display assigns colored borders to the currently defined windows. Near each window a softkey containing the first seven characters in the module's model number and address (row and column) are displayed in inverse video in the same color as the border. If a labeled softkey is pressed, the keyboard is offered to that window's instrument. If the instrument accepts the keyboard it will put up its menu keys, as though the **MENU** key had been pressed. For more information about address rows and columns, refer to "Understanding the HP-IB, MSIB, and the Address Map" in Chapter 9.

purge windowKey Path: **DISPLAY** Config Display purge window

- Actions:
- **purge window** removes a previously-defined window from the display screen.
 - The **SELECT WINDOW** softkey activates the window you wish to apply the **purge window** softkey to.
 - **PURGE ALL** removes all windows from the display screen, otherwise upon pressing **EXECUTE**, the window selected is destroyed, and any link with an instrument is broken. Trace information displayed in the window disappears from the screen.

Address Map

ADJUST
COLUMN

ADJUST
ROW

HP-IB
ADDRSET

ASSIGN
DISPLAY

ASSIGN
KEYBD

ASSIGN
BOTH

addrmap

Figure 5-8. Address Map Keys

The **Address Map** softkey accesses the Hewlett-Packard Modular System Interface Bus (MSIB) address map. The address map is a real-time graphical representation of HP 70000 Series modular measurement system elements and displays that are on the MSIB.

Note If, upon entering or after adjusting the address map, a red border appears within one of the address map boxes, an MSIB problem exists. The problem must be corrected before proceeding. The problem may exist in the module whose address resides in the red box or on that column. For more information about troubleshooting MSIB problems, refer to Chapter 2.

ADJUST COLUMN

ADJUST ROW

Key Path: **DISPLAY** **Address Map** **ADJUST ROW** or **ADJUST COLUMN**

- Actions:
- The **ADJUST COLUMN** and **ADJUST ROW** softkeys accept data entry from the display knob, from the **△** and **▽** keys, and from the numeric keypad.
 - The module currently highlighted in the address map will have a front panel green active light on. (The display represents its active light as a green A in the system state area located in the upper-left corner of the display.) This light enables you to correlate the specific HP 70000 Series modular measurement system elements to their locations in the address map.

HP-IB ADDRSETKey Path: **DISPLAY** Address Map **HP-IB ADDRSET**

- Actions:
- **HP-IB ADDRSET** changes the HP-IB address of any instrument currently on HP-IB if that instrument will permit it.
 - Some HP 70000 Series modular measurement system elements show an HP-IB address on the address map even though the element is disabled (by the HP-IB hard switch) and cannot communicate on HP-IB. (See MSIB earlier description in this section, or see the Installation and Verification Manual for your instrument). Modules, however show that they are disabled by replacing their HP-IB address with the word NO in the address map.
 - Upon power-up, the HP-IB addressing is handled differently by different elements. The display can be configured to have a power-up HP-IB address of either the MSIB column address or the most recent HP-IB address given to the display with **HP-IB ADDRSET**.

Note Some modules show HP-IB NO. This usually means that their HP-IB enable switch is in the off position.

ASSIGN DISPLAYKey Path: **DISPLAY** Address Map **ASSIGN DISPLAY**

- Actions:
- **ASSIGN DISPLAY** assigns the whole screen to a particular instrument, even though the keyboard may be assigned elsewhere. This allows the user to view the trace output from one instrument on the display, while controlling a different instrument with the keyboard. The two display resources, the keyboard and the display screen, can be allocated separately.

ASSIGN KEYBDKey Path: **DISPLAY** Address Map **ASSIGN KEYBD**

- Actions:
- The **ASSIGN KEYBD** softkey is used to allocate the keyboard to a specific module. The keyboard can then be used to control the instrument settings.
 - **ASSIGN KEYBD** lets the user link the keyboard with any master module by way of the address map.
 - Only a master module such as the HP 70900B local oscillator source can receive the keyboard. Attempts to allocate the keyboard to slave modules will result in an error.
 - The keyboard and the screen can be allocated separately. **ASSIGN KEYBD** links the keyboard with an instrument, but does not necessarily display any trace data from that instrument. Hence, the menu keys may not correspond to the instrument display shown.
 - Use **INSTR** as the primary way of transferring the keyboard between instruments once they are assigned to windows. When **INSTR** is pressed, the display assigns colored borders to the currently defined windows. Near each window a softkey containing the first seven characters in the module's model number and address (row and column) are displayed in inverse video in the same color as the border. If a labeled softkey is pressed, the keyboard

DISPLAY Address Map

is offered to that window's instrument. If the instrument accepts the keyboard it will put up its menu keys, as though **MENU** had been pressed.

ASSIGN BOTH

Key Path: **DISPLAY** Address Map **ASSIGN BOTH**

- Actions:
- **ASSIGN BOTH** establishes contact between the display and a specific instrument.
 - It then allocates the screen and keys to the module currently highlighted by the box in the address map.
 - In summary, **ASSIGN BOTH** establishes contact between the display (the user interface) and an HP 70000 Series modular measurement system element, but differs from **NEXT INSTR**. **ASSIGN BOTH**, used in the address map, requires that a particular module (element) be specified. **NEXT INSTR** selects an instrument on its own. Both, however, disconnect any links between the display and any other instruments. Both destroy any existing windows in the display.

DISPLAY Misc

Misc

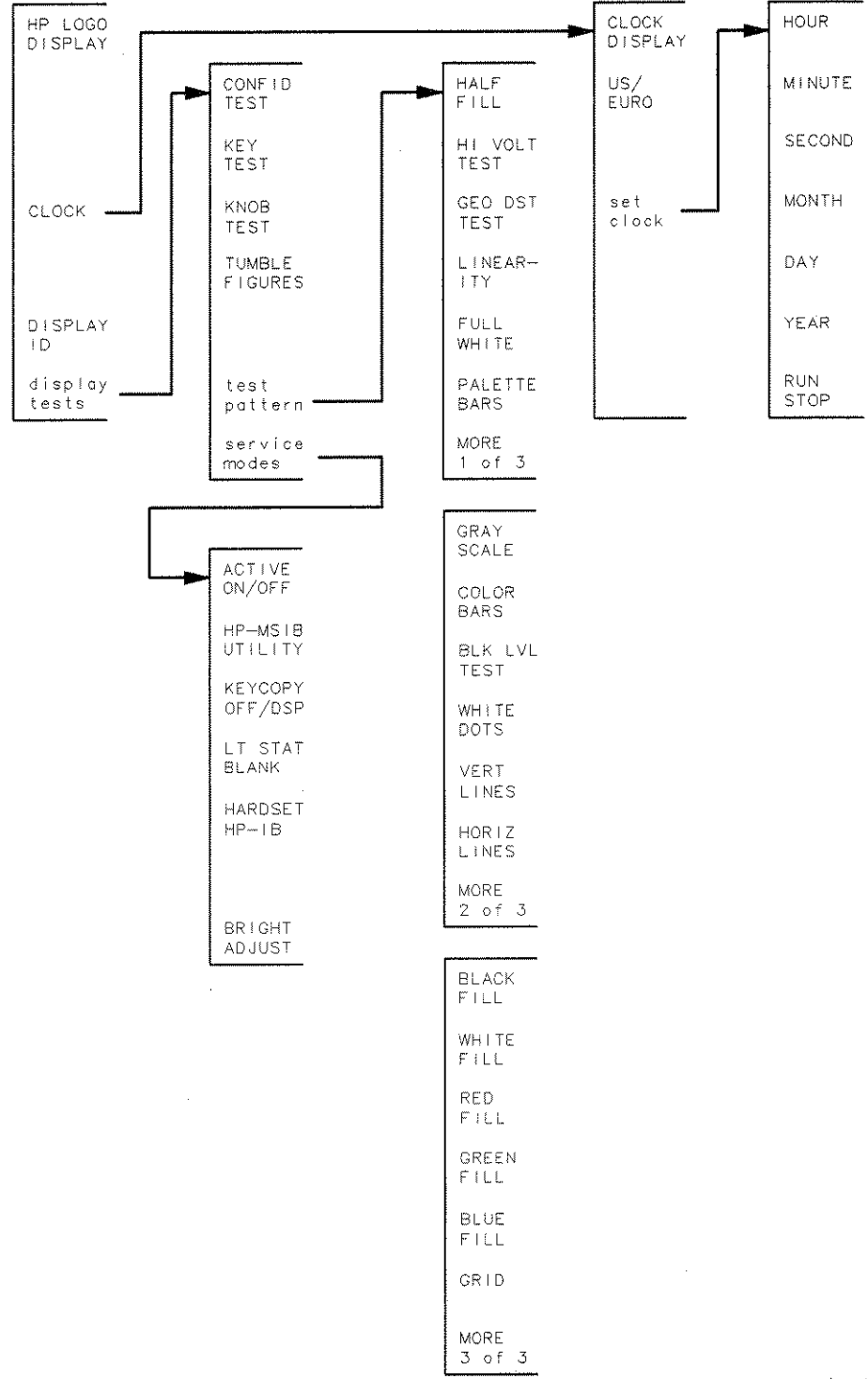

misc1

Figure 5-9. Misc Keys

DISPLAY Misc

The **Misc** (miscellaneous) softkey accesses a variety of functions, including: setting and removing the clock, removing the HP logo from the status window, and running service-related tests used to help troubleshoot the display.

HP LOGO DISPLAY

Key Path: **DISPLAY** Misc **HP LOGO DISPLAY**

- Actions:
- **HP LOGO DISPLAY** switches on (indicated by the underlined key label) or off.
 - When on (default), the HP logo in the status information area appears on the display screen.

clock

Key Path: **DISPLAY** Misc **clock**

- Actions:
- Displays a clock submenu.

The display has a real-time clock you can set that includes the time of day and date. The clock keeps time even when the power is removed from the display. The clock can be set in either US or European format. The following key functions can be accessed from the **clock** softkey. All inputs are numerical.

CLOCK DISPLAY

Key Path: **DISPLAY** Misc **clock** **CLOCK DISPLAY**

- Actions:
- **CLOCK DISPLAY** switches the real-time clock readout on and off.

When in the default state, on (indicated by the underlined key label), the real-time clock readout appears in the display's status information area.

US/EURO

Key Path: **DISPLAY** Misc **clock** **US/EURO**

- Actions:
- **US/EURO** allows the user to set the clock in either US or European format:
 - US Format: JUL 6, 1996 (Month-Day-Year)
 - European Format: 06.07.1996 (Day-Month-Year)

Set Clock

Key Path: **DISPLAY** Misc **clock** **Set Clock**

- Actions:
- **Set Clock** sets the time and date.

The display automatically keeps track of the current date and time, even while the display is turned off. *All clock inputs are numerical.* Enter the numbers with either the knob, step keys, or numerical keypad. Exit by pressing the **⏪** key or any other key. The **RUN/STOP** softkey switches the clock between stopped and running to aid in synchronizing the clock.

DISPLAY ID

Key Path: **DISPLAY Misc DISPLAY ID**

- Actions:
- **DISPLAY ID** displays the following information:
 - Color Palette.
(In 16 boxes centered on the top two rows. Colors 0–7 are on the top row, and 8–15 on the next row down.)
 - Copyright notice.
 - HP model number.
 - Firmware version.
 - MSIB address.
 - HP-IB address.
(Displays HP-IB Address: OFF if the rear panel HP-IB switch is off.)
 - Custom key-panel ID code.

Note The **DISPLAY ID** does not provide the ROM version of other instruments in the system. For that information, see the appropriate section of the operating instructions for your instrument. The display's MSIB address can only have a row address of zero. The factory-shipped default address is row 0, column 4 (0, 4).

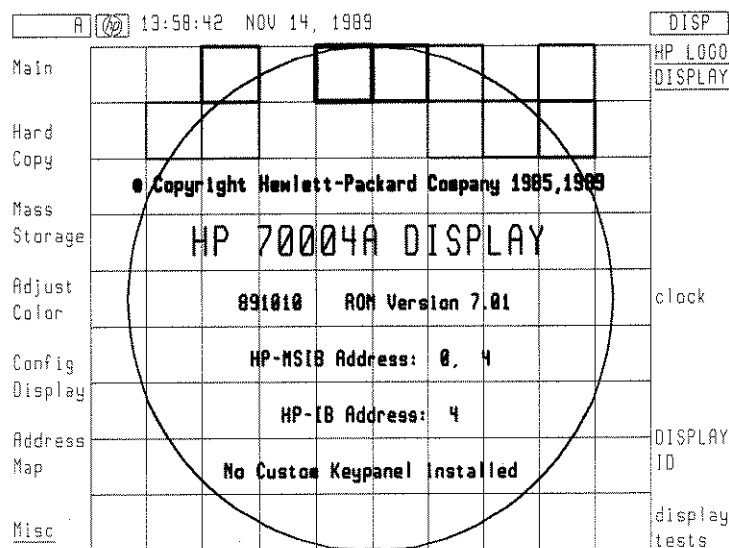

Display ID Screen

display tests

Key Path: **DISPLAY Misc display tests**

- Actions:
- Service personnel use the display tests to troubleshoot and repair the display. Most of these tests are fully documented in the service manual. Here is a brief description of the tests:

DISPLAY Misc

CONFID TEST

Key Path: **DISPLAY** Misc display tests CONFID TEST

Actions: ■ **CONFID TEST** initiated the Display Confidence test which checks the operation of roughly 90% of the display unit.

If no fault is found, 6001 Confidence test passed appears in the lower-left corner of the screen. If a fault is found, 6008 Confidence test failed appears. If an error is detected, refer to the installation and verification manual for your instrument.

KEY TEST

Key Path: **DISPLAY** Misc display tests KEY TEST

Actions: ■ **KEY TEST** checks the mechanical and electrical operation of every front panel key on the display.

KNOB TEST

Key Path: **DISPLAY** Misc display tests KNOB TEST

Actions: ■ **KNOB TEST** brings up a test pattern.

As the knob is turned, the test pattern rotates in a digital fashion. This provides a test of the mechanical and electrical operation of the display knob. Note that the step keys will rotate the pattern but the numeric entry keypad will not.

TUMBLE FIGURES

Key Path: **DISPLAY** Misc display tests TUMBLE FIGURES

Actions: ■ The tumble figure choices are:

CUBE BALL SLAB ROD HALF

While in tumble figures, pressing numbers on the display's front panel will affect the speed of rotation in each dimension. For example, 0, 0, 0 stops the rotation.

test pattern

Key Path: **DISPLAY** Misc display tests test pattern

Actions: ■ **test pattern** produces 18 test patterns used in display-troubleshooting and screen-alignment procedures.

The following demonstrations may inhibit normal system operation. Use the **←** hard key to exit.

HALF FILL

HI VOLT TEST

GEO DST TEST
 LINEARITY
 FULL WHITE
 PALETTE BARS
 GRAY SCALE
 COLOR BARS
 BLK LVL TEST
 WHITE DOTS
 VERT LINES
 HORIZ LINE
 BLACK FILL
 WHITE FILL
 RED FILL
 GREEN FILL
 BLUE FILL
 GRID

For more information about the tests, refer to the *HP 70004A Service Guide*.

service modes

Key Path: **DISPLAY** Misc display tests service modes

Actions: ■ These functions are used primarily for servicing the instrument. For more information about these functions, refer to the *HP 70004A Service Guide*. The **BRIGHT ADJUST** softkey is described here because it interacts with **INTEN ADJUST**.

BRIGHT ADJUST

Key Path: **DISPLAY** Misc display tests BRIGHT ADJUST

Actions: ■ **BRIGHT ADJUST** is used to adjust the offset voltage on the video signal and hence the background brightness of the screen. The normal setting is 8 and generally that is where it should be left.

If red fringes appear to the right of some colors, the selected intensity is set too high for the current brightness setting. Lower the intensity of the brightness setting.

Use the knob or numeric keypad to lower the brightness level if the red fringes appear.

Programming/Remote Operation

Programming Commands (Quick Reference)

Summary In this chapter you will learn about:

- Extension commands that are available to the HP 70004A color display, but are not documented in the *MMS Specification* documents.
-

The commands that are listed as “Keyboard”, “Graphics”, and “Storage” commands are documented in the *MMS Specification - Keyboard, Graphics, and Storage Language Reference, Revision 1.0*.

The commands that are listed as an “Extention” (to the *MMS Specification*) are commands that are available to the HP 70004A color display, but are not documented in the *MMS Specification* documents. Because these commands are still available to the HP 70004A color display, they have been documented here.

Programming Commands (Quick Reference)

- AE ALPHA ENTRY**
(Keyboard Command) This command allows a keyboard device to simulate a full ASCII keyboard.
- AF AREA FILL**
(Graphics Command) This command draws a rectangle of the specified size with the current pen.
- AK ASSIGN KEYBOARD**
(Extention Command) This command assigns the keyboard to the instrument which owns the specified window.
- AM ADDRESS MAP**
(Extention Command) This command initiates the display's address map function.
- AW ASSIGN SUBWINDOW**
(Graphics Command) This command defines a subsection of an already defined window to be used by another MSIB module.
- AX AXIS**
(Graphics Command) This command draws axes.
- BA BLANK AHEAD**
(Graphics Command) This command sets the number of points in the trace which will be blanked to the right of the last point plotted.
- BL BLINK ON/OFF**
(Graphics Command) This command turns the blink mode on or off.
- BP BEEP**
(Graphics Command) This command causes the graphics device to beep with the specified frequency and duration.
- BP BEEP**
(Keyboard Command) This command causes the keyboard device to beep with the specified frequency and duration.
- BP BEEP**
(Storage Command) This command causes the storage device to beep with the specified frequency and duration.
- BW BUILD WINDOW**
(Extention Command) This command builds a window on the screen, assigns an HP-MSIB or HP-IB element to that window, and determines whether to also assign the keyboard to that element.
- CA DESIGNATE ALTERNATE CHARACTER SET**
(Graphics Command) This command designates the character set that is to be used as the alternate character set.
- CF CATALOG FORMAT**
(Storage Command) This command formats the current mass storage device.
- CI SELECT INSTRUMENT**

Programming Commands (Quick Reference)

- (Extention Command) This command establishes a link with an instrument.
- CK CATALOG CLOSE**
- (Storage Command) This command closes a catalog.
- CL CONFIGURE LABEL**
- (Graphics Command) This command sets up a single line or multi-line label.
- CN COLOR NAME**
- (Keyboard Command) This command allows entry of a name to be associated with a keyboard device pen, for use in the color editor.
- CO CATALOG OPEN**
- (Storage Command) This command opens the catalog on the current mass storage device for reading.
- CR CATALOG READ**
- (Storage Command) This command reads a catalog record for one file from the current mass storage device.
- CS DESIGNATE STANDARD CHARACTER SET**
- (Graphics Command) This command designates the character set that is to be used as the standard character set.
- CY COPY**
- (Keyboard Command) This command initiates a hard copy print or plot.
- CZ OUTPUT CHARACTER SIZE**
- (Graphics Command) This command asks the graphics device for the size of the characters in the currently active item or group.
- DA DELETE ALL NON-REF/REF OBJECTS**
- (Graphics Command) This command deletes all referenced items and groups or all non-referenced objects within a window.
- DE DELETE SCREEN**
- (Extention Command) This command deletes everything showing on the screen.
- DF SET DEFAULT VALUES**
- (Graphics Command) This command sets certain parameters to a predefined state.
- DF SET DEFAULT VALUES**
- (Keyboard Command) This command sets certain parameters to a predefined state.
- DF SET DEFAULT VALUES**
- (Storage Command) This command sets certain parameters to a predefined state.
- DI SET CHARACTER DIRECTION ABSOLUTE**
- (Graphics Command) This command specifies the direction in which characters are lettered.

Programming Commands (Quick Reference)

DL	DELETE (Graphics Command) This command deletes the item or group which is currently selected.
DM	DRAWING MODE (Graphics Command) This command allows selection of several boolean or arithmetic replacement rules for graphics.
DR	SET CHARACTER DIRECTION RELATIVE (Graphics Command) This command specifies the direction in which characters are lettered relative to the width and length of the window in which they appear.
DS	DISPLAY STATUS ON/OFF (Keyboard Command) This command selects if the keyboard device annunciators and/or the character line box are to be displayed.
DT	DEFINE TERMINATOR (Graphics Command) This command defines the character to be used as the terminator of strings. Parameters of the LB (Label) command are affected.
DT	DEFINE TERMINATOR (Keyboard Command) This command defines the character to be used as the terminator of strings. Parameters of the FC (Fill Character Line) and ML (Menu Load) commands are affected.
DX	SET DELTA-X (Graphics Command) This command sets the X increment to be used in the graph instructions GA and GR.
EG	OUTPUT ERROR MESSAGE (Graphics Command) This command enables the user to get a text description of an error.
EG	OUTPUT ERROR MESSAGE (Keyboard Command) This command enables the user to get a text description of an error.
EG	OUTPUT ERROR MESSAGE (Storage Command) This command enables the user to get a text description of an error.
EJ	EJECT ON/OFF (Keyboard Command) This command enables/disables the eject after a plotter or printer dump.
ES	ERROR SCREEN (Extension Command) This command is equivalent to selecting the report errors utility on a display.
FC	FILL CHARACTER LINE (Keyboard Command) This command fills the character line at the bottom of the keyboard device with text.
FD	FILE DELETE

Programming Commands (Quick Reference)

	(Storage Command) This command deletes a file from the catalog of the current mass storage device.
FE	FILE ERROR
	(Storage Command) This command allows readout of the most recent file system error number.
FK	FILE CLOSE
	(Storage Command) This command closes a file.
FO	FILE OPEN
	(Storage Command) This command opens a file on the current mass storage device for reading or writing.
FR	FILE READ
	(Storage Command) This command reads data from a file.
FS	FILE SEEK
	(Storage Command) This command adjusts the file pointer for the next read or write.
FW	FILE WRITE
	(Storage Command) This command writes data to a file.
GA	GRAPH ABSOLUTE
	(Graphics Command) This command moves the pen to the location specified by the y-values.
GP	IDENTIFY GROUP
	(Graphics Command) This command references a group of objects on the screen.
GR	GRAPH RELATIVE
	(Graphics Command) This command moves the pen to the location specified by the Y-increments.
GT	GRATICULE
	(Graphics Command) This command draws a grid.
HF	HOLDOFF ON/OFF
	(Keyboard Command) This command stops the keyboard device from updating an integrated graphics device.
HR	HI RES ON/OFF
	(Keyboard Command) This command enables/disables full resolution printer dumps.
IA	INTENSITY ADJUST
	(Extention Command) This command allows the display brightness to be set remotely.
ID	OUTPUT IDENTIFICATION
	(Graphics Command) This command returns the graphics device identifier.
ID	OUTPUT IDENTIFICATION

Programming Commands (Quick Reference)

ID	<p>(Keyboard Command) This command returns the keyboard device identifier.</p> <p>OUTPUT IDENTIFICATION</p> <p>(Storage Command) This command returns the storage device identifier.</p>
IL	<p>INPUT LEARN STRING</p> <p>(Extension Command) This command prefixes a binary learn string being sent to the display. (Refer to the OL command.)</p>
IM	<p>INPUT MASK</p> <p>(Graphics Command) This command specifies the conditions under which errors will be reported and MSIB STATUS messages sent.</p>
IM	<p>INPUT MASK</p> <p>(Keyboard Command) This command specifies the conditions under which errors will be reported and MSIB STATUS messages sent.</p>
IM	<p>INPUT MASK</p> <p>(Storage Command) This command specifies the conditions under which errors will be reported and STATUS messages sent.</p>
IN	<p>INITIALIZE</p> <p>(Graphics Command) This command returns the window to initial power on state.</p>
IN	<p>INITIALIZE</p> <p>(Keyboard Command) This command returns the keyboard device to the initial setup state.</p>
IN	<p>INITIALIZE</p> <p>(Storage Command) This command returns the storage device to initial power on state.</p>
IS	<p>INTENSITY SELECT</p> <p>(Graphics Command) This command sets the intensity level of certain items on the windows.</p>
IT	<p>IDENTIFY ITEM</p> <p>(Graphics Command) This command requires a specific object on the screen.</p>
KC	<p>KEY COPY ON/OFF</p> <p>(Keyboard Command) This command enables/disables the ability of a keyboard device to copy the softkey labels.</p>
KM	<p>KEYCODE MAPPING</p> <p>(Keyboard Command) This command allows modules to optimally access the keyboard device's external keyboard.</p>
KP	<p>SIMULATE KEY PRESSED</p> <p>(Keyboard Command) This command accomplishes a phantom key press.</p>
KY	<p>SEND KEYBOARD DATA</p> <p>(Keyboard Command) This command is sent by a module in order to find out what key was pressed.</p>

Programming Commands (Quick Reference)

- LB LABEL**
(Graphics Command) This command puts text on the graphics device.
- LT SET LINE TYPE**
(Graphics Command) This command sets the line style to be used by the instructions AX, GA, GR, GT, PA, and PR.
- MA MARKER ATTRIBUTES**
(Graphics Command) This command defines the character and orientation attributes of the current marker (see MK, Marker).
- MK MARKER**
(Extention Command) This command places a marker at the specified coordinates.
- ML MENU LOAD**
(Keyboard Command) This command loads text into the specified menu key.
- MP SET MAPPING METHOD**
(Graphics Command) This command sets the mapping method to be used by the SC (Scale to User Units) command.
- MS MASS STORAGE IS**
(Storage Command) This command allows selection of the current mass storage device.
- OC OUTPUT MSIB CAPABILITY**
(Graphics Command) This command requests the current MSIB capability string.
- OC OUTPUT MSIB CAPABILITY**
(Keyboard Command) This command requests the current MSIB capability string.
- OC OUTPUT MSIB CAPABILITY**
(Storage Command) This command requests the current MSIB capability string.
- OD OUTPUT DATA**
(Storage Command) This command requests the current date setting of the real time clock.
- OD OUTPUT DATE**
(Graphics Command) This command requests the current date setting of the real time clock.
- OD OUTPUT DATE**
(Keyboard Command) This command requests the current date setting of the real time clock.
- OE OUTPUT ERROR**
(Graphics Command) This command makes the error number list available for output.
- OE OUTPUT ERROR**

Programming Commands (Quick Reference)

- (Keyboard Command) This command makes the error number list available for output.
- OE OUTPUT ERROR**
- (Storage Command) This command makes the error number list available for output.
- OG OUTPUT GRAPHICS LINK**
- (Graphics Command) This command requests the address of a graphics link owner.
- OG OUTPUT GRAPHICS LINK**
- (Keyboard Command) This command requests the address of a graphics device owner, in a combined keyboard and graphics device.
- OH OUTPUT HARD LIMITS**
- (Graphics Command) This command requests the hard screen limits from the graphics device.
- OH OUTPUT HARD LIMITS**
- (Keyboard Command) This command requests the hard screen limits for an integrated graphics device from the keyboard device.
- OI OUTPUT IDENTIFICATION**
- (Graphics Command) This command makes the graphics device identifier available for output to a module.
- OI OUTPUT IDENTIFICATION**
- (Keyboard Command) This command makes the keyboard device identifier available for output to a module.
- OI OUTPUT IDENTIFICATION**
- (Storage Command) This command makes the storage device identifier available for output to a module.
- OL OUTPUT LEARN STRING**
- (Extension Command) This command requests that a display output the information required to return it to the state it is presently in.
- ON OUTPUT SERIAL NUMBER**
- (Graphics Command) This command requests the graphics device's serial number.
- ON OUTPUT SERIAL NUMBER**
- (Keyboard Command) This command requests the keyboard device's serial number.
- ON OUTPUT SERIAL NUMBER**
- (Storage Command) This command requests the storage device's serial number.
- OO OUTPUT OPTIONS**
- (Graphics Command) This command outputs the graphics device options.
- OO OUTPUT OPTIONS**
- (Keyboard Command) This command outputs the keyboard device options.

Programming Commands (Quick Reference)

- OO OUTPUT OPTIONS**
(Storage Command) This command outputs the storage device options.
- OP OUTPUT P1,P2**
(Graphics Command) This command requests the location of the lower left (P1) and the upper right (P2) vertices of the window.
- OR SET ORIGIN**
(Graphics Command) This command sets an offset that will be added to all objects before they are drawn.
- OS OUTPUT STATUS**
(Graphics Command) This command makes the status byte available for output to the MMS module.
- OS OUTPUT STATUS**
(Keyboard Command) This command makes the status byte available for output to the module.
- OS OUTPUT STATUS**
(Storage Command) This command makes the status byte available for output to the module.
- OT OUTPUT TIME**
(Graphics Command) This command requests the current setting of the real time clock.
- OT OUTPUT TIME**
(Keyboard Command) This command requests the current setting of the real time clock.
- OT OUTPUT TIME**
(Storage Command) This command requests the current setting of the real time clock.
- OV OUTPUT VERSION**
(Graphics Command) This command asks for the firmware version and the date code.
- OV OUTPUT VERSION**
(Keyboard Command) This command asks for the firmware version and the date code.
- OV OUTPUT VERSION**
(Storage Command) This command asks for the firmware version and the date code.
- OY OUTPUT CAPABILITY**
(Graphics Command) This command provides the means to determine if a particular graphics device recognizes a given command.
- PA PLOT ABSOLUTE**
(Graphics Command) This command moves the pen to the position specified.
- PC PEN COLOR**

Programming Commands (Quick Reference)

	(Graphics Command) This command allows modification of the color map remotely.
PD	PEN DOWN (Graphics Command) This command lowers the pen without moving it to a new location.
PG	PAGE (Graphics Command) This command erases all information presented on the window.
PI	PRINTER/PLOTTER IS (Keyboard Command) This command specifies the printer or plotter for use with the CY (Copy) command.
PL	PLOTTER LIMITS (Keyboard Command) This command sets the points P1, P2 in memory to be used for "listen-only" type plotter dumps.
PN	PAN (Graphics Command) This command allows panning of a graph.
PP	PRE-PROCESS MODE (Extention Command) This command allows the controller to receive all keyboard inputs, no matter which element owns the keyboard.
PR	PLOT RELATIVE (Graphics Command) This command moves the pen to a new location relative to its present location.
PU	PEN UP (Graphics Command) This command raises the pen without moving it to a new location.
RC	RECALL STATE (Extention Command) This command recalls a setup from non-volatile memory and has the display go to that state.
RG	SIMULATE RPG TURNED (Keyboard Command) This command simulates turning of the knob.
RL	READ LOCATOR (Keyboard Command) This command is used to read the mouse or knob counts.
RM	REMAINING MEMORY (Graphics Command) This command determines memory available in the graphics device.
RM	REMAINING MEMORY (Keyboard Command) This command determines memory available in the keyboard device.
RM	REMAINING MEMORY (Storage Command) This command determines memory available in the storage device.

Programming Commands (Quick Reference)

RP	SEND RPG DATA (Keyboard Command) This command asks the keyboard device for the accumulated knob count since the last reading of the knob.
SA	SELECT ALTERNATE CHARACTER SET (Graphics Command) This command selects the alternate character set as the character set to be used for all subsequent characters.
SC	SCALE TO USER UNITS (Graphics Command) This command establishes a user-unit system by mapping the P1 and P2 (corner) points of a window onto the scaling points P1 and P2.
SI	SET ABSOLUTE CHARACTER SIZE (Graphics Command) This command specifies the size of characters and symbols in graphics units.
SN	SHOW CONFIGURATION (Extention Command) This command remotely invokes the display's show config function.
SP	SELECT PEN (Graphics Command) This command selects a pan for drawing subsequent objects.
SR	SET RELATIVE CHARACTER SIZE (Graphics Command) This command specifies the size of characters and symbols in user units.
SS	SELECT STANDARD CHARACTER SET (Graphics Command) This command selects the standard character set as the character set to be used for all subsequent characters.
SU	SAVE USER DEFINED CHARACTER (Graphics Command) This command creates symbols to be added to character set 30.
SV	SAVE STATE (Extention Command) This command saves a display state in non-volatile memory.
SW	SWEEP ON/OFF (Extention Command) This command provides the means to turn off the sweep circuits in the display, thus blanking the picture.
TE	SELF TEST (Extention Command) This command initiates the display's internal self test.
TP	TRACE POINTER (Graphics Command) This command specifies the starting point in a graph or plot that the next graph command (GA or GR) or plot command (PA or PR) will modify.
UC	USER DEFINED CHARACTER

Programming Commands (Quick Reference)

- (Graphics Command) This command draws symbols not included in the graphics device's character sets.
- VW **VIEW ON/OFF**
- (Graphics Command) This command is used to blank or un-blank the current item or group.
- WK **WHICH KEYPAD**
- (Keyboard Command) This command requests the identification number of the current custom keypad.
- WM **WHICH MENU**
- (Keyboard Command) This command sets the active menu annunciator

Programming Commands (Extention Manual Pages)

The commands that are listed as an "Extention" (to the *MMS Specification*) are commands that are available to the HP 70004A color display, but are not documented in the *MMS Specification* documents. Because these commands are still available to the HP 70004A color display, they have been documented here.

For information on commands that are not documented here, but are in the quick reference list, refer to the *MMS Specification* documents.

AK

ASSIGN KEYBOARD

(Extention Command) This command assigns the keyboard to the instrument which owns the specified window.

AM

ADDRESS MAP

(Extention Command) This command initiates the display's address map function.

BW

BUILD WINDOW

(Extention Command) This command builds a window on the screen, assigns an HP-MSIB or HP-IB element to that window, and determines whether to also assign the keyboard to that element.

CI

SELECT INSTRUMENT

(Extention Command) This command establishes a link with an instrument.

DE

DELETE SCREEN

(Extention Command) This command deletes everything showing on the screen.

ES

ERROR SCREEN

(Extention Command) This command is equivalent to selecting the report errors utility on a display.

Programming Commands (Extention Manual Pages)

IA

INTENSITY ADJUST

(Extention Command) This command allows the display brightness to be set remotely.

IL

INPUT LEARN STRING

(Extention Command) This command prefixes a binary learn string being sent to the display.
(Refer to the OL command.)

MK

MARKER

(Extention Command) This command places a marker at the specified coordinates.

OL

OUTPUT LEARN STRING

(Extention Command) This command requests that a display output the information required to return it to the state it is presently in.

PP

PRE-PROCESS MODE

(Extention Command) This command allows the controller to receive all keyboard inputs, no matter which element owns the keyboard.

RC

RECALL STATE

(Extention Command) This command recalls a setup from non-volatile memory and has the display go to that state.

SN

SHOW CONFIGURATION

(Extention Command) This command remotely invokes the display's show config function.

SV

SAVE STATE

(Extention Command) This command saves a display state in non-volatile memory.

SW

SWEEP ON/OFF

(Extention Command) This command provides the means to turn off the sweep circuits in the display, thus blanking the picture.

TE

SELF TEST

(Extention Command) This command initiates the display's internal self test.

Specifications and Characteristics

Summary In this chapter you will learn about:

- General specifications and characteristics for the HP 70004A color display.
-

Specifications

Specifications describe warranted performance over a temperature range of 0° to +50°C after one hour of continuous operation, unless otherwise noted. Specifications apply after system temperatures have stabilized and the self-calibration routines have run.

Unless otherwise noted, corrected limits are given when specification range is improved with error-correction routines. All specifications qualified by an output power setting refer to that setting.

Typical performance, where listed, is *not warranted*, but indicates performance which most units will meet.

Characteristics

Characteristics provide useful, but *non-warranted* functional and performance information.

Nominal Values

Nominal Values indicate the expected, but *non-warranted* value of the denoted parameter.

General Specifications

Temperature	Operation 0° C to +55° C Storage -40° C to +75° C
EMI	Radiated interference is within the requirements of MIL-STD 461B, Class A1c RE02, CE03
RGB Outputs	75 Ω impedance (sync on green) Signal Level White Positive-into 75 Ω 1 Vpp ±10% Bandwidth Approx 25 MHz
Fan Noise	5.0 Bels SPL
Warm-up Time	15 minutes from a cold start (0° to 55° C)
Weight (nominal value)	19.5 kg (43 lb)
Dimensions	Height 221.5 mm (8.72 in) Width 421.2 mm (16.58 in) Length 523 mm (20.6 in) Length (w/handles) 566 mm (22.3 in)
AC Power Input, Line Ranges	87–132 Vac 50/60/400 Hz 174–264 Vac 50/60 Hz
VA Rating	260 W maximum 350 VA maximum

Error Messages

Summary In this chapter you will learn about:

- Error code information that is reported on the HP 70004A color display.

2000 – 2999 Usage Errors	8-2
Display-Disruptive Error Messages	8-3
6000 – 6999 Hardware-Warning Errors	8-5
7000 – 7999 Hardware-Broken Errors	8-6
9000 – 9999 Factory Use Errors	8-7

Note Before taking any action based on these error messages, make sure all the boards are firmly seated and all cables are securely fastened.

2000—2999 Usage Errors

Usage errors are those that occur during normal display operation and usually indicate an error elsewhere in the system.

2001 Illegal command

The display has been sent a command it does not recognize. For example in HP BASIC, the command `OUTPUT @Display;"XX"` would generate this error.

2002 Illegal parameter

An item has been sent a command that does not match (for example, sending **LB** to a **PA** type item), a **CL** command has been sent in **GP0**, or a bad learn-string has been sent.

2005 Illegal character set

An attempt has been made to specify a character set (using **CA** or **CS**) that is not available in the display.

2006 Parm out of range

A parameter that violates the range specification for a given command has been sent.

2007 Missing terminator

A command has been sent to the display without a valid terminator.

2009 Protocol error

A command has been sent to the display that requires a link type that is not currently established between the sender and the display.

2011 Memory overflow

An attempt has been made to allocate more vector list memory than the display contains. Usually this means that the user is trying to display more traces than the display's memory can support, or that too many strokes have been sent in non-referenced graphics.

Display-Disruptive Error Messages

Display-disruptive errors are those that interfere with normal display operation and error reporting. The associated error messages indicate faulty display hardware. The error messages are shown in two ways:

- The error message in large block letters on an otherwise blank display.
- An LED pattern on the A6 Host Board Assembly.

RAM ADDR ERROR

A test of CMOS RAM has failed. The data in CMOS RAM is read, saved, and complemented. Every other address is then tested to see if the data is unchanged. The test failed.

RAM DATA ERROR (U19)

RAM DATA ERROR (U20)

A test of CMOS RAM has failed. Data is cycled through all the address locations on the data bus. Each time data is written, it is read back and compared with the written data. At least one comparison failed.

ROM 23 CHECKSUM

ROM 24 CHECKSUM

ROM 25 CHECKSUM

ROM 26 CHECKSUM

A checksum was calculated on all ROMs and one or more ROMs failed.

A5 8041 INTERFACE

Communications failed between the 8041 processor chip and the host processor chip. The 8041 processor chip is instructed to send a data sequence to the host processor chip, which if received correctly should verify the 8041 and the link to it.

A5 Graphics VRAM

A test of the VIDEO RAM failed. The host processor has attempted to write a decrementing data pattern to incrementing addresses and then read and verify each location.

Display-Disruptive Error Messages

A5 GRAPHICS DRAM

A test of the DRAM RAM failed. The host processor has attempted to write a decrementing data pattern to incrementing addresses and then read and verify each location.

A5 GRAPHICS PROCESSOR

A test of the graphics processor system has failed. The host processor chip has attempted to read and verify the contents of a location in the graphics system DRAM. The graphics system processor loads this location with a known pattern during its initialization.

6000—6999 Hardware-Warning Errors

The following error codes are generated by faults that may impair measurement accuracy. These errors will be noted by the E in the upper-left corner of the display. The errors may be viewed by pressing the **DISPLAY** key then the **REPORT ERRORS** menu key.

6002 A5 nonvolatile RAM (battery?)

A5 RAM memory failed a checksum test. If cycling LINE power does not clear the error, replace the battery on the processor board.

6008 Confidence Test Failed

A display self-test has failed. Confidence Test Failed appears on the bottom of the screen at power-up (if an error was detected) or after a confidence test **CONFID TEST**. The same test sequence can be invoked remotely with the TE command. If any test fails, the bus which sent the TE command will be notified. If this occurs because of a TE command, cycle power; a display-disruptive error should be displayed, which will indicate the problem. If this occurs at power-up, press **DISPLAY** and **REPORT ERRORS** will identify the problem.

7000—7999 Hardware-Broken Errors

The following error codes are generated by faults within the instrument. These errors will be noted by the E in the upper-left of the CRT. The errors may be viewed by pressing the **DISPLAY** key and then the **REPORT ERRORS** menu key.

7038 A5 Error in 8041

Communications failed between the 8041 processor and the host processor. The 8041 processor is instructed to send a data sequence to the host processor, which if received correctly should verify the 8041 and the link to it.

7040 A5 GSP Checksum error

A test of the graphics system processor has failed. A test pattern was loaded into the video RAM by the graphics processor. A checksum of the video RAM was calculated by the host processor.

7060 A5 RAM Data (U20)

7061 A5 RAM Data (U19)

A test of CMOS RAM has failed. Data is cycled through all the address locations on the data bus. Each time data is written, it is read back and compared with the written data. At least one test failed.

7062 A5 RAM Address

A test of CMOS RAM has failed. The data in CMOS RAM is read, saved, and complemented. Every other address is then tested to see if the data is unchanged.

7063 A5 ROM U24 Checksum

7064 A5 ROM U26 Checksum

7065 A5 ROM U23 Checksum

7066 A5 ROM U25 Checksum

A checksum is calculated on all ROMs.

7092 A5 Graphics processor

A test of the graphics processor system has failed. The host processor chip has attempted to read and verify the contents of a location in the graphics system DRAM. The graphics system processor loads this location with a known pattern during its initialization.

9000—9999 Factory Use Errors

Note The 9000—9999 series error messages are rare and generally not seen. If error messages in this series are encountered, record all possible information and contact the nearest Hewlett-Packard Sales and Service Office.

Concepts

Summary In this chapter you will learn about:

- Concepts related to the HP-IB/MSIB addressing scheme that is used in the MMS system.
 - Concepts related to using the RGB video outputs as well as general information on the use of color.
-

This chapter provides concept information that is related to the use of the HP 70004A color display.

Understanding the HP-IB, MSIB, and the Address Map	9-2
Understanding RGB Video Outputs and Their Use	9-4
Understanding the Use of Color	9-7

Understanding the HP-IB, MSIB, and the Address Map

MSIB Addressing Scheme

The MSIB has a two-dimensional addressing scheme. Each system element such as the HP 70900B local oscillator source or the HP 70004A color display has a two-part bus address. The address consists of a row number and a column number; for example, 0, 18 (ROW, COLUMN). This unique address serves as an identifier so that any element can talk with any other element on MSIB, regardless of physical proximity or other bus traffic.

The address map is designed so that each element can be located by its unique address. The row address (first number) specifies the horizontal row of the grid where the element is located, and the column address specifies the vertical column. Rows have numbers 0 through 7 (0 is at the bottom of the screen) and columns are numbered 0 through 31 (0 at the left edge of the map). The address 0, 31 is not available for use, so there are 255 available addresses.

Each modular measuring instrument (composed of one or more modules) occupies all or part of a single column. (The exception to this is multi-column instruments. See the installation and verification manual for your instrument. Note that the display elements (HP 70205A graphics display/HP 70206A system graphics display, and HP 70004A color display) are not explicitly part of any measuring instrument. Each display serves as a general-purpose human-machine interface, providing a screen for the instruments and keys that enables the user to control the system. Since the displays are not part of any particular instrument, each will occupy its own column in the address map.

Note A more detailed description of MSIB addressing conventions is given in the installation and verification manual for your instrument's system-master module.

MSIB addresses are set only by switches located on each module or display. All elements, modules and displays, have adjustable column addresses. All elements *except* the displays have adjustable row addresses. (The displays are confined to ROW 0.)

An appropriate element, when located in ROW 0, acts as a master to all modules above and to the right of it; this master has control as far as the column of the next master, which supersedes the first. The master module is able to control another module by ordering it to perform tasks and by controlling the flow of information to and from that module. For example, an error detected in an IF section will be reported to the master module, which will in turn report it to the user via the display. In HP 70000 Series modular measurement systems configured as spectrum analyzers, the master module is the HP 70900B local oscillator source. Displays are not masters; they do not control modules, although they allow users to.

The modules controlled by a master are referred to as slaves. Slave modules are addressed above the master; that is, slaves have higher row addresses than their master. A measuring instrument such as a spectrum analyzer will typically consist of one master (local oscillator module) and several slaves (IF sections, RF front-end sections, tracking generators, and so on). While a master module must be located in ROW 0, slave modules can be addressed in any of several rows.

MSIB addresses must be unique. Setting two HP 70000 Series modular measurement system elements to the same address will create an error and make the system bus (MSIB) inoperative. If the cursor cannot be moved about within the address map after a module has been re-addressed, check to see if two modules have the same row and column address. If so, removal of the modules is required. See the installation and verification manual for your instrument for instructions. If the MSIB is inoperative at power-up, some or all modules will indicate this by blinking their error LED (the display blinks its E annunciator).

To test for an inoperative MSIB:

Cycle power and check the E annunciator or annunciators.

HP-IB, MSIB, and the Address Map

Although HP-IB and MSIB are different buses, some elements on MSIB are accessible via HP-IB. Specifically, certain elements that have an MSIB row address of 0 may be addressed over HP-IB with the proper configuration.

A brief discussion of HP-IB usage with HP 70000 Series modular measurement system will be presented here, but a more detailed coverage is given in the installation and verification manual for your instrument.

Between mainframes (for example, the HP 70004A color display and HP 70001A mainframe) HP-IB and MSIB are completely separate and are carried on separate cables. HP-IB is a parallel-connected single cable bus; MSIB is a series-connected dual-cable bus. Two HP 70000 Series modular measurement system mainframes are connected to the same HP-IB network only if each is connected to it individually, or if there is an HP-IB cable linking the two. The HP 70206A system graphics display also connects to the system over separate HP-IB and MSIB cables.

Within a single mainframe, HP-IB and MSIB connections are carried along the backplane bus and are provided at the back of each 1/8-width module slot. A mainframe has one HP-IB port (one connector) and one MSIB port (two connectors: one in and one out). With these connectors, all modules in a particular mainframe have access to both the HP-IB lines and the MSIB lines.

All modules can communicate over MSIB, but, as previously mentioned, only certain modules or elements can talk over HP-IB. Therefore, while every HP 70000 Series modular measurement system element takes up an MSIB address, only the ROW 0 modules can occupy HP-IB addresses. Among the HP 70000 Series modular measurement system elements that can use HP-IB are the HP 70900B local oscillator source, HP 70004A color display, and HP 70205A graphics display/HP 70206A system graphics display.

Each system element that can talk over HP-IB can also be removed from HP-IB by positioning the HP-IB ON/OFF switch in the off position. (Some modules indicate this by putting a NO in the address map in place of their HP-IB address.) On the displays, this switch is readily accessible from the back panel. On the HP 70900B local oscillator source, the switch is located on the top of the module, along with the other HP-IB and MSIB switches. Changing any of these switches on the local oscillator requires removal of the module from the mainframe. See the installation and verification manual for your instrument for more information.

Note The HP-IB address and the MSIB address of a system element are not necessarily related.

The MSIB address is determined solely by the setting of the address switches on the module. Refer to the installation and verification manual for your instrument. When applicable, the HP-IB address of each module defaults to the MSIB column address. For example, the MSIB address 0, 18 has a default HP-IB address of 18. Note, however, that the HP-IB address of the local oscillator and of both displays may be set to any valid address using **HP-IB ADDRSET**, which is available through **address map**. (Refer to "To set the HP-IB address of a module through front-panel softkeys" in Chapter 4.)

Understanding RGB Video Outputs and Their Use

Understanding the resolution of MMS displays

The resolution of MMS displays are 1024 dots across by 400 lines (384 lines on the HP 70205A graphics display/HP 70206A system graphics display). This is 400 horizontal picture lines; not to be confused with vertical lines of resolution (a figure of merit sometimes applied to video cameras and broadcast monitors).

Understanding the video output signal

The term **composite video** means that the synchronization and video information is combined in a single signal. The HP 70004A color display GREEN output is a composite video signal. The HP 70004A color display RED and BLUE outputs are not composite video signals, because there is no synchronization information on them.

Composite video does not mean that all the picture information is combined in a single signal; although, when using a monochrome display, all of the picture information is combined. Using color displays require three separate outputs to convey all of the information.

In the case of the HP 70004A color display, the above description applies only to the GREEN output. There is no synchronization information on the RED or BLUE outputs; otherwise they are the same as the GREEN output.

The **video output signal** from the HP 70004A color display is an analog signal, 1 volt peak-to-peak. The upper 0.7 volts contains the video (brightness) information and the lower 0.3 volts contains the synchronization information. That is, one line of video looks similar to the following:

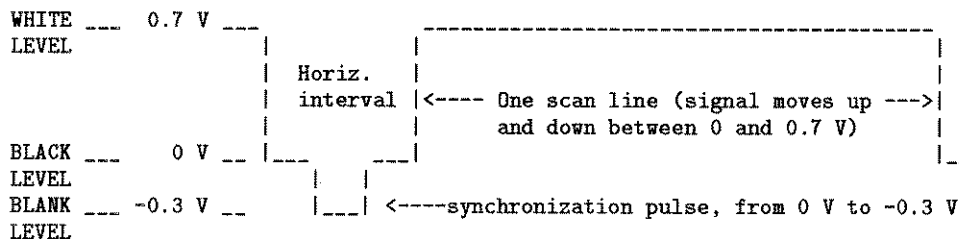

Understanding the video encoding

Often, when the term "composite video" is used, what is really meant is NTSC. NTSC [National Television System Committee] is the standard for video encoding used in the US and Japan. It is a means of combining synchronization, luminance (brightness), and chrominance (color) information into a single wide-band video signal that can be transmitted or recorded. PAL is another system widely used in Europe for the same purpose. In addition, because the MMS display format was developed before EGA or VGA existed, MMS does not follow any of these standards: NTSC, PAL, EGA, VGA. Neither PAL or NTSC permits the resolution required by MMS; the MMS horizontal scan frequency is 25 kHz, far greater than that used by either PAL or NTSC. In addition, the color display uses three separate outputs (R, G, and B) to get the information out. There is no output which combines all three colors into a single signal, as would be required for PAL or NTSC, even if the sweep frequencies were compatible (which they are not).

Understanding RGB Video Outputs and Their Use

The MMS system is compatible with the older (HP 9000 Series 310) low resolution computer displays. For this reason, the HP 35721/31/41 monitors operate compatibly with MMS.

Selecting an external monitor

The type of **external monitor** that is needed is a monitor that will operate at 25 kHz horizontal sweep frequency and 60 Hz vertical sweep frequency.

Compatible monitors are:

- Sony 1302
- Sony 1303
- Sony 1391
- HP 35741A
- NEC MULTISYNC 2

WARNING You must be very careful about trying to use monitors or projection TV systems that are not designed for 25 kHz operation. They may appear to synchronize up or may just barely synchronize up so that you think they are working, but operation at unspecified frequencies can severely damage raster monitor systems.

Videotaping the video output

You must be aware that the vertical sweep frequency is 60 Hz,

Most VCR's designed for NTSC recording will synchronize up to the 60 Hz vertical sweep frequency of the HP 70004A color display, because they typically slave themselves to the vertical scan. However, the horizontal sweep frequency of the MMS system is 25 kHz, which is higher than what VCR's are designed to record, and the video bandwidth is 25 to 30 MHz, which is higher than what VCR's are designed to work with. Nonetheless, we have seen several VCR's that will record the picture. However, the recording still must be played back on a monitor with a 25 kHz horizontal sweep frequency. A regular TV monitor will not work any better on a picture videotaped this way than it will with the monitor outputs themselves.

For the HP 70004A color display, you would need a VCR with RGB inputs to record it in color (no VCR of this type exists to our knowledge). Instead, record using just the GREEN output. This works best if you use the MONOCHROME button under the **Adjust Color** menu to map the multi-colored screen into multi-levels of green intensity.

If you want to record the picture as part of a demonstration video, in NTSC or PAL so that it is recorded on a normal VHS, BETA, or U-MATIC VCR, it cannot be done. Unfortunately, the only way to make a recording for a VHS, BETA, or U-MATIC VCR, is to point a camera at the screen and record. This will work quite well in countries with 60 Hz video systems, but not as well with 50 Hz systems because of the beat note between the 60 Hz MMS scan rate and the 50 Hz video system.

Understanding RGB Video Outputs and Their Use

Tips for making good videotapes with a camera

- videotape in a dark environment. This eliminates glare as well as the potential for flicker generated by overhead fluorescent.
- turn the intensity of the display down, to improve the focus (and convergence in color systems).
- use a long (telephoto) focal length to minimize curvature distortion from the tube.
- fill the camera screen with the picture as much as possible for maximum resolution.
- if flicker is a problem in 50 Hz countries, try using a non-CCD video camera so that you can take advantage of the tube's persistence. If you do use a CCD camera, make sure to use a long shutter speed.

Understanding the Use of Color

While it is beyond the scope of this manual to provide an exhaustive guide to color use, a few comments can be made on using color effectively.

The RGB Model (Red, Green, Blue)

The RGB model can be thought of as mixing the output of three colored light sources (one each or red, green, and blue). The parameters in the model specify the intensity of each of the light sources.

The HSL Model (Hue, Saturation, and Luminosity)

The HSL model is closer to the intuitive model of color used by artists, and is very effective for interactive color selection. The three parameters represent hue (the pure color), saturation (the ratio of the pure color mixed with white), and luminosity (the brightness-per-unit area). The hue parameter rotates a color wheel to select a "pure" color to use. This pure color is then mixed with white light. The saturation slider controls the ratio of the pure colored light to white light. Finally, the output passes through the luminosity iris (think of the iris as an adjustable hole) that controls the brightness of the output.

Seeing Color

The human eye responds to wavelengths of electromagnetic radiation from about 400 nm to about 700 nm (4000 to 7000 angstrom). We call this visible light. Visible light ranges from violet (400 nm) to red (700 nm). If all the frequencies of visible light are equally mixed, the result is called white light.

The eye's ability to discriminate color is reduced as the light level is reduced. This means that the variety of colors perceivable at low light levels is smaller than the variety at higher light levels.

The eye is most sensitive to colors in the middle of the visible spectrum, a yellow-green color. The eye is least sensitive to the shorter wavelengths at the blue end of the spectrum. Sensitivity to red is between that of yellow-green and blue. Two things seem to be associated with the sensitivity of the eye to various colors:

- The eye can distinguish the widest range of colors in the yellow-green region, and the smallest variety of colors in the blue region.
- The eye is most sensitive to detail in the yellow-green region.

It's All Subjective, Anyway

One of the reasons that there are so many color theories is that no two people seem to perceive color the same way. In fact, the same person may perceive color differently at different times. In addition to the physiological and psychological variables in color perception, many environmental factors are important. Ambient light and surrounding color affect the perceived color tremendously.

At this point, it will be well worth your time to try the following example. Try setting the background color to different settings, and see how different the foreground colors look against the different background colors. The only way to insure a set of colors works well together is to try them and see.

Understanding the Use of Color

Mixing Colors

If two distinct audio tones are played simultaneously, you will hear both of them. If an object is illuminated by two or more different colors of light, you will not perceive the original colors of light, but rather a single color, and it will not be one of the original colors. What you perceive is called the *dominant wavelength*.

The display screen uses three different colored phosphors (red, green, and blue) and mixes various intensities of the resulting lights to produce one of the 4096 colors at any point on the display. What you actually see is the resulting dominant wavelength. This is an additive color system.

Mixing pigments is a little different. The pigments in ink and paint absorb light. The idea with pigments is to subtract all but the color you want out of a white light source. This is a subtractive color system, and the primary colors are cyan, magenta, and yellow.

The different mechanisms for mixing additive and subtractive colors makes it difficult to reproduce images created with additive colors (CRT) in a subtractive medium (a plotted or printed page). A more in-depth discussion of this issue is found under "Color Hard Copy."

Color Gamuts

The range of colors a physical system can represent is called its *color gamut*. Color gamuts are important when you want to convert between different physical systems, because the source system may be able to produce colors the destination system cannot reproduce. An exhaustive treatment of color gamuts is beyond the scope of this manual. However, here are some rules of thumb:

- The color gamuts for CRT's and photographic film are not the same, but are fairly close. If you are lucky, you can photograph the CRT and catch it on film. It may take more than one exposure, so be careful and bracket everything with several exposures.
- The color gamut for printing is significantly smaller that of either photographic film or of a CRT. The fact that you have a picture of a CRT does not mean you can hand it to a printer and get a faithful reproduction of it.
- The color gamut of a plotter or color printer is much smaller than that of a CRT. You have to create images with limitations of a plotter (or printer) in mind if you intend to reproduce them on a plotter or printer. See "Plotting and the CRT" below.

If you have to reproduce CRT images, keep these differences in mind.

Objective Color Use

In spite of the subjectivity of color, there are some fairly objective things that you should know about color. Some of the things that can be done with color don't depend heavily on subjective interpretation.

Color Blindness

Two enhanced color palettes in the **special colors** menu deal with the most common form of color blindness, the inability to distinguish red and green. These palettes avoid encoding information using red-green discrimination.

Viewing Red Lasers

The optical filter option accommodates the use of protective goggles while viewing lasers.

Color Hard Copy

Color hard copy is a translation between two different color systems. The color gamuts available to the CRT and the hard copy device are different. See "Color Gamuts" above.

There are three ways to get a color hard copy of information displayed on the HP 70004A color display:

- Take a picture of the CRT.
- Generate an image of the CRT with an external plotter.
- Generate an image of the CRT with an external printer.

The first method can usually capture whatever is on the CRT, regardless of what colors are used. The last two are the easiest, but are not likely to capture exactly what you see on the screen. All three methods are discussed below.

Photographing the CRT

Photography is an art, not a science. Capturing images off a CRT is relatively straightforward, but sometimes unpredictable due to the different color gamuts available on film and the CRT. The following suggested guidelines will provide a starting point. You may need to experiment with photographing the CRT. If your images don't turn out as expected, you may have to go back and re-photograph them.

- Use ISO 64 Color film.
- Set up your equipment in a room that can be darkened. It will have to be darkened for the one-second exposure.
- Use a telephoto lens (the longer the better, up to about 500 mm). This minimizes the effects of the curvature of the CRT.
- Use a tripod.
- Darken the room and take a one-second exposure.
- Bracket the aperture around f5.6. (One stop above and below.)

Plotting/Color Printing and the CRT

There are two basic reasons the CRT is hard to capture on a plotter or color printer.

- The CRT is an additive color device and both the plotter and printer are subtractive color devices.
- The color gamut of the CRT is much larger than that of either the plotter or printer.

The conversion from additive to subtractive colors is not a huge problem if the plot is a simple line drawing with few intersections. If the plot is complex, especially with lots of intersection, the plot is much less likely to capture the display image accurately.

While it is possible to get some idea of the picture that will be produced on the plotter or the printer, don't be surprised if they don't look exactly the same. Colors on a CRT are different in source and form from colors on either the plotter or printer, as described under "Seeing Colors" above. The colors available on the external devices are very limited.

Understanding the Use of Color

Note The colors printed on the PaintJet are a function of the *color number* of each item on the screen, not the *color* of each item on the screen. The PaintJet's colors do not change when on-screen colors are changed using the Adjust Colors Menu.

Subjective Color Use

Choosing appropriate colors for the display screen can be tricky. We at Hewlett-Packard have spent considerable effort selecting a palette for your use. This palette is based in large part on the results of research into color perception. In the final analysis, however, it is also a matter of trying combinations until you come up with a set of colors that look good together. There are a few fundamental things to remember in choosing your colors.

Choosing Colors

- Try varying the luminosity or saturation of a color.
- Pastels (less than fully-saturated colors) tend not to clash.
- Give careful attention to your background color.
 - If you are using a small number of colors, use the complement of one of them for the background.
 - If you are using a large number of colors, try a gray background.
- Avoid large values of contrast, that is, greatly varying luminosity levels. Instead achieve contrast through hue.
- Avoid colors difficult to display or difficult to focus (like magenta) for primary instrument displays.

Color References

The following references deal with color and vision. Texts that serve as useful introductions to the topic are starred.

Cornsweet, T., *Visual Perception*. New York: Academic Press, 1970. *

Farrell, R.J. and J.M Booth, *Design Handbook for Imagery Interpretation Equipment*. (AD/A-025453) Seattle, WA: Boeing Aerospace Co., 1975.

Graham, C. H., (Ed.) *Vision and Visual Perception* New York: J. Wiley & Sons Inc., 1965.

Hurvich, L.M., *Color Vision: An Introduction*. Sunderland, MA; Sinauer Assoc., 1980. *

Judd, D.B., *Contributions to Color Science*. Edited by D. MacAdam; 545 NBS Special Publication. Washington, DC: U.S. Government Printing Office, 1979.

Rose, A.,. *Vision: Human and Electronic*. New York: Plenum, 1973. *

Index

A

- A1–A8 switches, 3-17
- A5 8041 interface, 8-3
- A5 graphics DRAM, 8-4
- A5 graphics processor, 8-4
- A5 graphics VRAM, 8-3
- A6–A8 switches, 3-17
- access light
 - memory card, vii, 3-10
- accessories, 1-18
- ac line switch, vii, 3-10
- addressing, HP 70004A color display, 1-8
- addressing scheme, MSIB, 9-2
- address map, default MSIB, 2-3
- address map, HP-IB, MSIB, 9-3
- address switches, 3-16
- adjustment, intensity, 4-19
- arrow
 - backspace, vii, 3-9
 - down, vii, 3-10
 - up, vii, 3-10

B

- backspace key, vii, 3-9
- ball driver, latch screw, 3-2
- battery-low indicator
 - memory card, vii, 2-6, 3-10
- blank display, 2-4
- blinking E, 2-6

C

- color
 - blindness, 9-8
 - choosing, 9-10
 - gamuts, 9-8
 - hard copy, 9-9
 - it's all subjective, anyway, 9-7
 - mixing, 9-8
 - objective use, 9-8
 - printing/plotting, 9-9
 - references, 9-11
 - seeing, 9-7
 - subjective use, 9-10
- confidence test, 2-9
- configure display, 5-22
- connecting ac line power, 1-15

- connector, HP-HIL, vii, 3-10
- conventions
 - notation, viii
 - softkey, viii
- cooling, 3-3
- CRT, photographing, 9-9
- custom instrument keypad, vii, 3-9

D

- definition
 - default MSIB address map, 2-3
- digital knob
 - front panel (RPG), vii, 3-10
- display
 - blank or distorted, 2-4
 - character text area, 3-4
 - configure, 5-22
 - connecting to HP 70001A mainframe, 1-7
 - disruptive error messages, 8-3
 - graphics area, 3-4
 - ID, 2-13
 - key, 3-8
 - menu status area, 3-4
 - softkey menus area, 3-4
 - status information area, 3-4
 - system state area, 3-4
 - tests, 2-8

DISPLAY Address Map

- ADJUST COLUMN**, 5-26

- ADJUST ROW**, 5-26

- ASSIGN BOTH**, 5-28

- ASSIGN DISPLAY**, 5-27

- ASSIGN KEYBD**, 5-27

- HP-IB ADDRSET**, 5-27

DISPLAY Adjust Color

- DEFAULT COLORS**, 5-17

- edit colors**, 5-16

- MONOCHROME**, 5-18

- RECALL COLORS**, 5-16

- SAVE COLORS**, 5-16

- special colors**, 5-18

DISPLAY Config Display

assign window, 5-25
build window, 5-22
build window **BUILD (#) WINDOW(S)**,
5-24
build window custom windows, 5-22
build window **STACK (#) WINDOW(S)**,
5-24
purge window, 5-25
RECALL CONFIG, 5-22
SAVE CONFIG, 5-22
SHOW CONFIG, 5-22

DISPLAY Hard Copy

copy options, 5-10
plotter address, 5-10
plotter config, 5-8
printer address, 5-8
printer config, 5-7

display key, vii

DISPLAY Main

DISPLAY PRESET, 5-3
INTEN ADJUST, 5-5
NEXT INSTR, 5-4
REPORT ERRORS, 5-5

DISPLAY Mass Storage

msi, 5-12
msi HP-IB disk, 5-14
msi HP-IB disk **HP-IB ADDRESS**, 5-14
msi HP-IB disk **UNIT NUMBER**, 5-14
msi HP-IB disk **VOLUME NUMBER**, 5-14
msi **MEMORY CARD**, 5-13

DISPLAY Misc

clock, 5-30
clock **CLOCK DISPLAY**, 5-30
clock **Set Clock**, 5-30
clock **US/EURO**, 5-30
DISPLAY ID, 5-31
display tests, 5-31
display tests **BRIGHT ADJUST**, 5-33
display tests **CONFID TEST**, 5-32
display tests **KEY TEST**, 5-32
display tests **KNOB TEST**, 5-32

display tests **service nodes**, 5-33
display tests **test pattern**, 5-32
display tests **TUMBLE FIGURES**, 5-32
HP LOGO DISPLAY, 5-30

DISPLAY PRESET vs. **INSTR PRESET**, vi,
3-6
distorted display, 2-4
driver, 8 mm hex-ball, 3-2

E

entry number, vii, 3-10
erase volatile and non-volatile user RAM,
4-38
ERR indicator, 2-6
error code

2001, 8-2
2002, 8-2
2005, 8-2
2006, 8-2
2007, 8-2
2009, 8-2
2011, 8-2
6002, 8-5
6008, 8-5
7038, 8-6
7040, 8-6
7060, 8-6
7061, 8-6
7062, 8-6
7063, 8-6
7064, 8-6
7065, 8-6
7066, 8-6
7092, 8-6

A5 8041 interface, 8-3
A5 graphics DRAM, 8-4
A5 graphics processor, 8-4
A5 graphics VRAM, 8-3
RAM ADDR error, 8-3
RAM data error (U19), 8-3
RAM data error (U20), 8-3
ROM 23 checksum, 8-3
ROM 24 checksum, 8-3
ROM 25 checksum, 8-3
ROM 26 checksum, 8-3
error messages
display disruptive, 8-3
hardware-broken, 8-6
hardware-warning, 8-5
usage, 8-2
external monitor, selecting, 9-5

F

- fault indicator, 2-5
 - blinking E, 2-6
 - ERR indicator, 2-6
 - status box, 2-6
- fault light, MSIB, vi, 3-7
- features
 - cooling, 3-3
 - display section, 3-2
 - HP-IB, 3-2
 - mainframe section, 3-2
 - menu keys, 3-2
 - module latch, 3-2
 - MSIB, 3-2
 - power supplies, 3-2
 - rack and stack, 3-2
 - remote programmability, 3-3
- front panel
 - 0-9, 3-10
 - △, ▽, 3-10
 - DISPLAY, 3-7
 - HOLD, 3-9
 - INSTR, 3-8
 - INSTR PRESET, 3-6
 - LCL, 3-7
 - ←, 3-9
 - line on/off switch, 3-10
 - MENU, 3-8
 - multi-state functions, 3-8
 - PLOT, 3-7
 - PRINT, 3-7
 - regions, 3-4
 - RPG knob, 3-10
 - softkey functions, 3-7
 - softkeys, 5-1
 - USER, 3-8
- front panel knob, vii
- front panel light
 - memory card access, vii, 3-10
 - memory card battery-low, vii, 3-10
 - MSIB, vi, 3-7
- front panel switch
 - line on/off, vii
- function keys, instrument keypad, 3-12

H

- hardware-broken error messages, 8-6
- hardware-warning error messages, 8-5
- Hewlett-Packard Human Interface Link, vii
- Hewlett-Packard Human Interface Link (HP-HIL), 3-10
- Hewlett-Packard Interface Bus (HP-IB), 3-2
- Hewlett-Packard Modular System Interface Bus (MSIB), 3-2
- hex-ball driver, 3-2

hold key, vii, 3-9

how to

- access a window over HP-IB, 4-6
- access the menu keys of an instrument, 4-6
- adjust the brightness of the display, 4-19
- assign both the display and keyboard to an instrument, 4-9
- assign the display (only) to an instrument, 4-8
- assign the keyboard (only) to an instrument, 4-8
- build 1, 2, or 4 windows on the display, 4-3
- build custom sized windows on the display, 4-5
- change the battery on a RAM memory card, 4-35
- change the monochrome display to different shades of green, 4-18
- change the special color elements, 4-18
- clear the display, 4-15
- customize display colors, 4-17
- erase volatile and non-volatile user RAM, 4-38
- establish a link to an instrument, 4-6
- examine errors reported by the display, 4-38
- format a memory card, 4-37
- install a memory card, 4-34
- print to an HP-IB printer, 4-24
- print to an HP LaserJet Series printer, 4-23
- print to an HP PaintJet printer, 4-25
- print to an HP ThinkJet printer, 4-26
- purge a window configuration, 4-14
- purge configuration registers, 4-14
- recall a system configuration, 4-13
- recall custom display colors, 4-19
- return to default display colors, 4-19
- save a system configuration, 4-12
- save custom display colors, 4-18
- save your work to a permanent storage media device, 4-31
- select an HP-IB disk drive as a storage device, 4-32
- select the memory card as a mass storage device, 4-33
- select US or European clock style, 4-20
- set the display clock, 4-21
- set the display color to monochrome, 4-17
- set the HP-IB address of a master module, 4-9
- set the HP-IB/MSIB address of the HP 70004A color display, 4-10

- set the plotter address of an MMS plotter, 4-29
- set the plotter address of a non-MMS plotter, 4-28
- set the plotter configuration, 4-28
- set the printer address of an MMS printer, 4-27
- set the printer address of a non-MMS printer, 4-27
- show system configurations, 4-11
- stack 2 or 4 windows on the display, 4-4
- test MSIB, 9-3
- turn the HP logo ON or OFF, 4-38
- view column and row addresses in the address map, 4-7
- view current display information (firmware, address, model, etc.), 4-39
- HP 70001A mainframe, connecting to display, 1-7
- HP-HIL, vii, 3-10
 - connector, vii, 3-10
 - keyboards, vii, 3-10, 3-13
 - mouse, vii, 3-10
 - track ball, vii, 3-10
- HP-IB, 3-2
 - changes from front panel, 3-17
 - on/off switch, 3-17
- HP-IB, MSIB, address map, 9-3
- HSL model (hue, saturation, and luminosity), 9-7

I

- indicator light, MSIB, 2-5
- indicator, RAM memory card battery-low, 2-6
- INSTR key, vii, 3-8
- INSTR PRESET key, vi, 3-6
- INSTR PRESET vs. DISPLAY PRESET, vi, 3-6
- instrument
 - key, vii, 3-8
 - keypad, 3-11
 - keypad function keys, 3-12
 - preset key, vi, 3-6
- intensity, adjustment, 4-19

K

- key
 - backspace, vii, 3-9
 - display, vii, 3-8
 - display preset, vi, 3-6
 - down, vii, 3-10
 - hold, 3-9
 - INSTR, vii, 3-8
 - INSTR PRESET, vi, 3-6

- instrument, vii, 3-8
- instrument preset, vi, 3-6
- menu, vii, 3-8
- plot, vii, 3-7
- print, vii, 3-7
- step, vii, 3-10
- test, 2-10
- up, vii, 3-10
- user, vii, 3-8
- keyboards
 - configuration, 3-13
 - HP-HIL, vii, 3-10
 - interface, 3-13
 - keycodes, 3-14
- key, hold, vii
- keypad
 - custom instrument, vii, 3-9
 - function keys, 3-12
 - numeric, vii, 3-10
 - spectrum analyzer instrument, 3-11
- knob, RPG, vii
- knob test, 2-11

L

- lasers, viewing red, 9-9
- latch, module, 3-2
- LIF files, 5-12
- light
 - memory card access, vii, 3-10
 - memory card battery-low, vii, 3-10
- line switch, ac, vii, 3-10

M

- making videotapes with a camera, 9-6
- manual organization, viii
- memory card, vii, 3-10
 - access light, vii, 3-10
 - battery-low light, vii, 3-10
 - slot, vii, 3-10
- menu key, vii, 3-8
- menu keys, softkeys, 3-2
- module
 - latch, 3-2
 - removal, 3-2
 - slots, 3-2
- module, serial numbers, 2-15
- mouse, vii, 3-10
- MSIB, 3-2
 - fault light, vi, 3-7
 - indicator light, 2-5
 - problem, 2-6
 - troubleshooting, 2-5
- MSIB addressing scheme, 9-2
- MSIB, address map, HP-IB, 9-3

N

notation, viii
NTSC, 9-4
number entry, vii, 3-10
numeric keypad, vii, 3-10

O

off, line switch, vii, 3-10
on, line switch, vii, 3-10
operation, remote, 1-9

P

panel, snap-in, vii, 3-9
photographing the CRT, 9-9
plot key, vii, 3-7
plotting/color printing, 9-9
power
 input, 3-2
 output, 3-2
 requirements, 7-1
print key, vii, 3-7
purge volatile and non-volatile user RAM,
 4-38

R

RAM ADDR error, 8-3
RAM data error, 8-3
RAM memory card
 battery-low indicator, 2-6
RCA to BNC adapters, video outputs, 3-16
reinstate front panel operation, 3-7
relative locator device
 mouse, vii, 3-10
 track ball, vii, 3-10
remote operation, 1-9
removal, module, 3-2
resolution of MMS displays, understanding,
 9-4
returning to last menu, —, 3-9
RGB model (red, green, blue), 9-7
ROM 23 checksum, 8-3
ROM 24 checksum, 8-3
ROM 25 checksum, 8-3
ROM 26 checksum, 8-3
RPG knob, vii

S

selecting an external monitor, 9-5
serial numbers, module, 2-15
slot
 memory card, vii, 3-10
 module, 3-2
snap-in panel, vii, 3-9

softkeys, viii
 menu keys, 3-2
 order they are described, 5-1
specifications
 EMI, 7-1
 power requirements, 7-1
 temperature, 7-1
spectrum analyzer
 instrument keypad, functions, 3-11
status box, 2-6
step key, vii, 3-10
switch
 A1—A8, 3-17
 A6—A8, 3-17
 HP-IB on/off, 3-17
 system controller, 3-17
 talk only, 3-17
 test mode, 3-18
system
 controller switch, 3-17

T

talk only, switch, 3-17
test mode, switch, 3-18
tests
 confidence, 2-9
 confidence test, 1-17
 display, 2-8
 key, 2-10
 knob, 2-11
 pattern, 2-12
track ball, vii, 3-10
tumble figures, 2-12

U

understanding
 resolution of MMS displays, 9-4
 video encoding, 9-4
 video output signal, 9-4
usage error messages, 8-2
user key, vii, 3-8

V

video encoding, understanding, 9-4
video output signal, understanding, 9-4
video outputs, RCA to BNC adapters, 3-16
videotaping
 from the video output, 9-5
 using a camera, 9-6
viewing red lasers, 9-9

W

weight, 7-1